



Product Description

RFMD's SBF4089Z is a high performance InGaP/GaAs Heterojunction Bipolar Transistor MMIC Amplifier. A Darlington configuration designed with InGaP process technology provides broadband performance up to 0.5GHz with excellent thermal performance. The heterojunction increases breakdown voltage and minimizes leakage current between junctions. Cancellation of emitter junction non-linearities results in higher suppression of intermodulation products. Only a single positive supply voltage, DC-blocking capacitors, a bias resistor, and an optional RF choke are required for operation.

Optimum Technology Matching® Applied

- GaAs HBT
- GaAs MESFET
- InGaP HBT
- SiGe BiCMOS
- Si BiCMOS
- SiGe HBT
- GaAs pHEMT
- Si CMOS
- Si BJT
- GaN HEMT
- InP HBT
- RF MEMS
- LDMOS

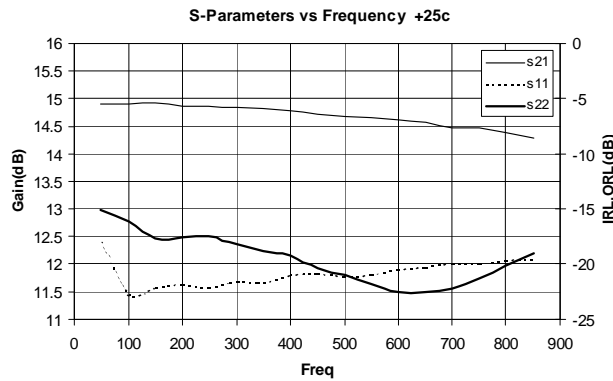

Features

- IP₃ = 42 dBm at 240 MHz
- Stable Gain Over Temperature
- Robust 1000V ESD, Class 1C
- Operates From Single Supply
- Low Thermal Resistance

Applications

- Receiver IF Amplifier
- Cellular, PCS, GSM, UMTS
- PA Driver Amplifier
- Wireless Data, Satellite Terminals

Parameter	Specification			Unit	Condition
	Min.	Typ.	Max.		
Small Signal Gain		14.9		dB	70 MHz
	13.3	14.8	16.3	dB	240 MHz
	13.2	14.7	16.2	dB	500 MHz
Output Power at 1dB Compression		20.1		dBm	70 MHz
		20.1		dBm	240 MHz
	18.4	19.9		dBm	400 MHz
Output Third Order Intercept Point		40.0		dBm	70 MHz
		42.0		dBm	240 MHz
	39.0	41.0		dBm	400 MHz
Input Return Loss	13.0	17.0		dB	500 MHz
Output Return Loss	12.0	16.0		dB	500 MHz
Noise Figure		3.3	4.3	dB	500 MHz
Device Operating Voltage	4.5	4.9	5.3	V	
Device Operating Current	82	90	98	mA	
Thermal Resistance		43		°C/W	junction to lead

Test Conditions: V_S = 8V, I_D = 90 mA Typ., T_L = 25 °C. OIP₃ Tone Spacing = 1 MHz, P_{OUT} per tone = 0 dBm, R_{BIAS} = 33 Ω. Data with Application Circuit.

Absolute Maximum Ratings

Parameter	Rating	Unit
Device Current (I_D)	150	mA
Device Voltage (V_D)	6	V
Max Operating Dissipated Power	0.8	W
Max Input Power Rating	15	dBm
Junction Temp (T_J)	+150	°C
Operating Temp Range (T_L)	-40 to +85	°C
Storage Temp	+150	°C
ESD Rating - Human Body Model (HBM)	Class 1C	
Moisture Sensitivity Level	MSL 2	



Caution! ESD sensitive device.

Exceeding any one or a combination of the Absolute Maximum Rating conditions may cause permanent damage to the device. Extended application of Absolute Maximum Rating conditions to the device may reduce device reliability. Specified typical performance or functional operation of the device under Absolute Maximum Rating conditions is not implied.

The information in this publication is believed to be accurate and reliable. However, no responsibility is assumed by RF Micro Devices, Inc. ("RFMD") for its use, nor for any infringement of patents, or other rights of third parties, resulting from its use. No license is granted by implication or otherwise under any patent or patent rights of RFMD. RFMD reserves the right to change component circuitry, recommended application circuitry and specifications at any time without prior notice.



RFMD Green: RoHS compliant per EU Directive 2002/95/EC, halogen free per IEC 61249-2-21, < 1000ppm each of antimony trioxide in polymeric materials and red phosphorus as a flame retardant, and <2% antimony in solder.

Operation of this device beyond any one of these limits may cause permanent damage. For reliable continuous operation, the device voltage and current must not exceed the maximum operating values specified in the table on page one.

Bias Conditions should also satisfy the following expression:

$$I_D V_D < (T_J - T_L) / R_{TH, J-I} \text{ and } T_L = T_{LEAD}$$

Typical RF Performance at Key Operating Frequencies

Parameter	Unit	70MHz	100MHz	240MHz	400MHz	500MHz	850MHz
Small Signal Gain	dB	14.9	14.9	14.9	14.8	14.7	14.3
Output Third Order Intercept Point	dBm	40.0	40.5	42.5	41.0	40.0	35.1
Output Power at 1dB Compression	dBm	20.1	20.1	20.1	19.9	20.1	18.1
Input Return Loss	dB	18	22	22	21	21	19
Output Return Loss	dB	15	16	17	19	21	18
Reverse Isolation	dB	18	18	18	18	18	18
Noise Figure	dB	3.2	3.3	3.3	3.3	3.3	3.3

Test Conditions: $V_S = 8V$, $I_D = 90mA$ Typ., OIP₃ Tone Spacing = 1MHz, P_{OUT} per tone = 0dBm. $T_L = 25^\circ C$, R_{BIAS} = 33Ω, Z_S = Z_L = 50Ω, App circuit.

P1dB vs Temp

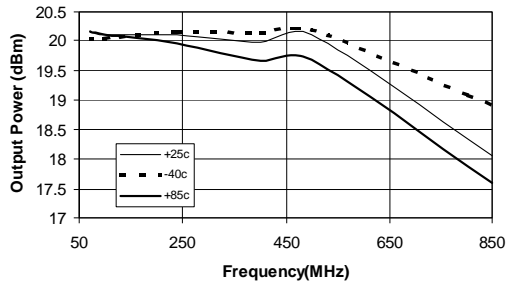

TOIP vs Temp

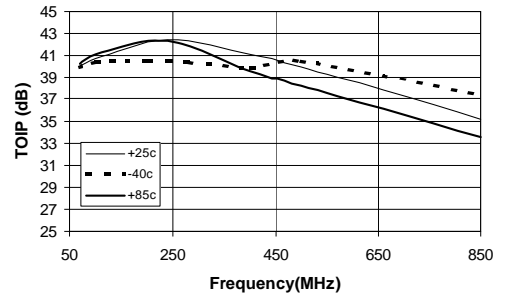

Noise Figure vs Temp

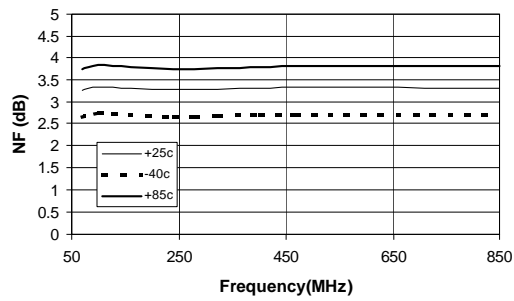

Test Conditions: $V_S=8V$, $R_{BIAS}=33\Omega$, $I_D=90mA$, $T=+25^\circ C$,

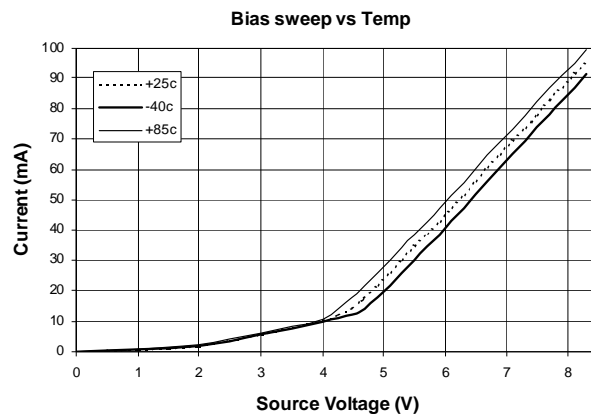
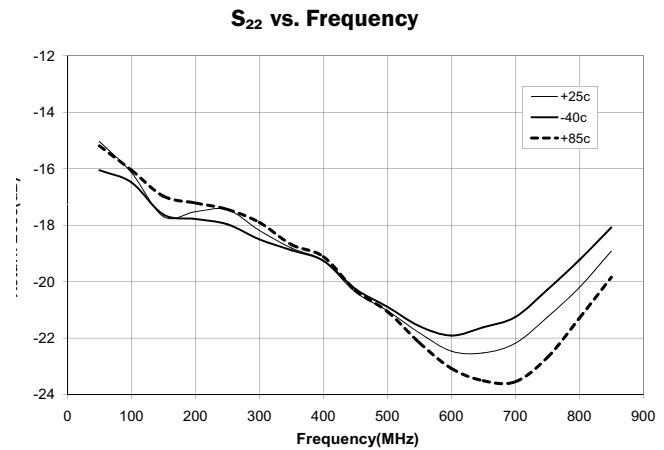
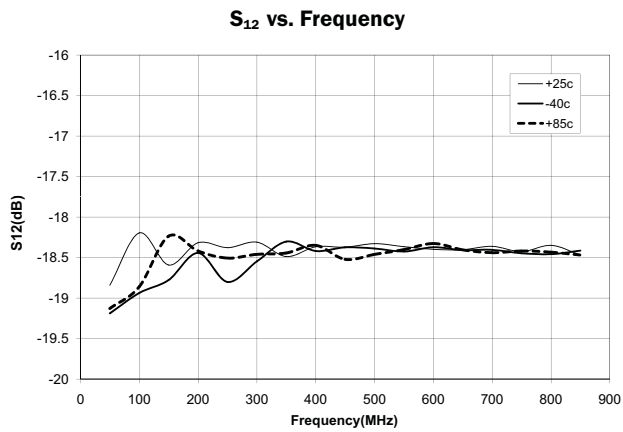
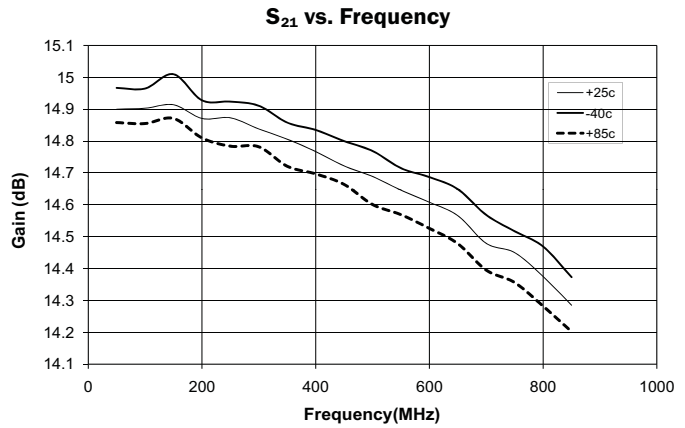
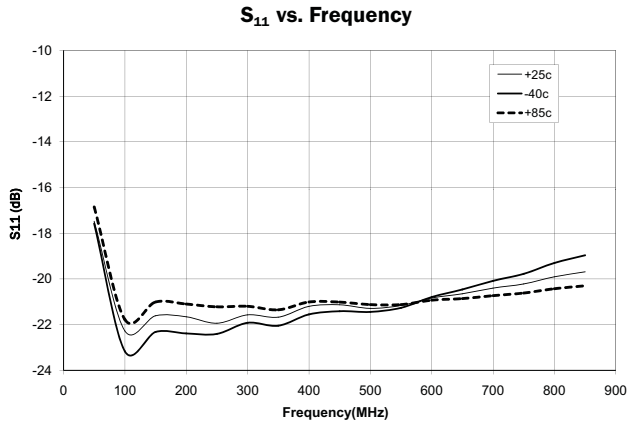

Note: Output Return Loss can be improved at low end of band with L1 selection.

Application Circuit Schematic

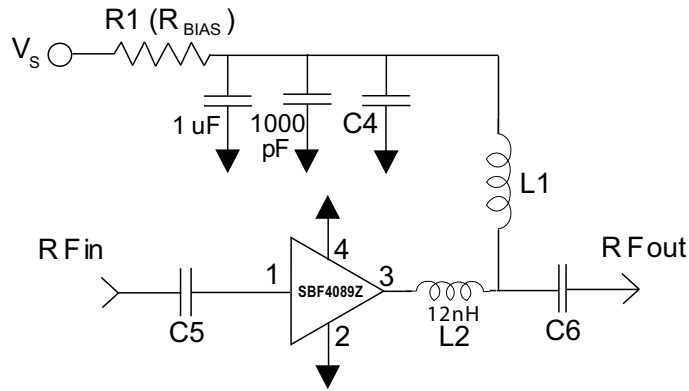

Application Circuit Element Values

Reference Designator	70MHz	100MHz	240MHz	500MHz	850MHz
C5, C6	1 uF	1000 pF	1000 pF	220 pF	100 pF
C4	100 pF	100 pF	100 pF	100 pF	68 pF
L1	6.8 uH	1.2 uH	1.2 uH	68 nH	33 nH
L2	6.8 nH	12 nH	12 nH	6.8 nH	6.8 nH

Recommended Bias Resistance for I_D = 90 mA

Supply Voltage (V _S) (Volts)	7.5	8	10	12
Bias Resistance (Ω)	27	33	56	75

Note = R_{BIAS} provides DC bias stability over temperature.

Evaluation Board Layout

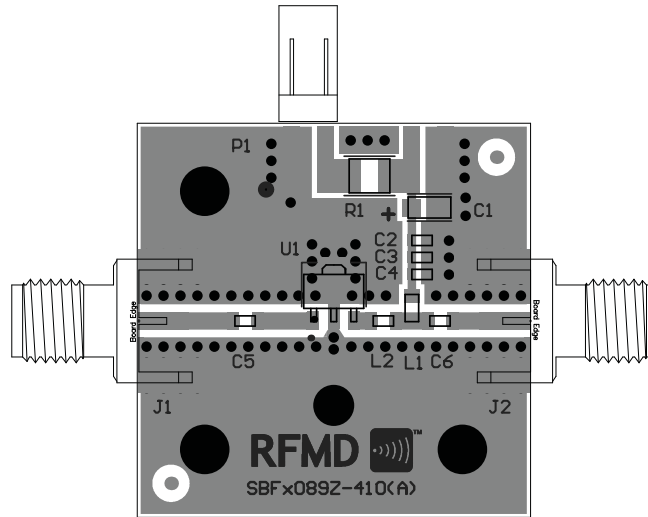

Mounting Instructions

1. Note: For broadband RF unconditional stability do not put GND vias under the exposed backside GND paddle.
2. Solder the copper pad on the backside of the device package to the ground plane.
3. Use a large ground pad area with many plated through-holes as shown.
4. We recommend 1 or 2 ounce copper. Measurement for this data sheet were made on a 31 mil thick FR-4 board with 1 ounce copper on both sides.

Pin	Function	Description
1	RF IN	RF input pin. This pin requires the use of an external DC-blocking capacitor chosen for the frequency of operation.
2, 4	GND	Connection to ground. Use via holes for best performance to reduce lead inductance as close to ground leads as possible.
3	RF OUT/BIAS	RF output and bias pin. DC voltage is present on this pin therefore a DC-blocking capacitor is necessary for proper operation.

Suggested Pad Layout

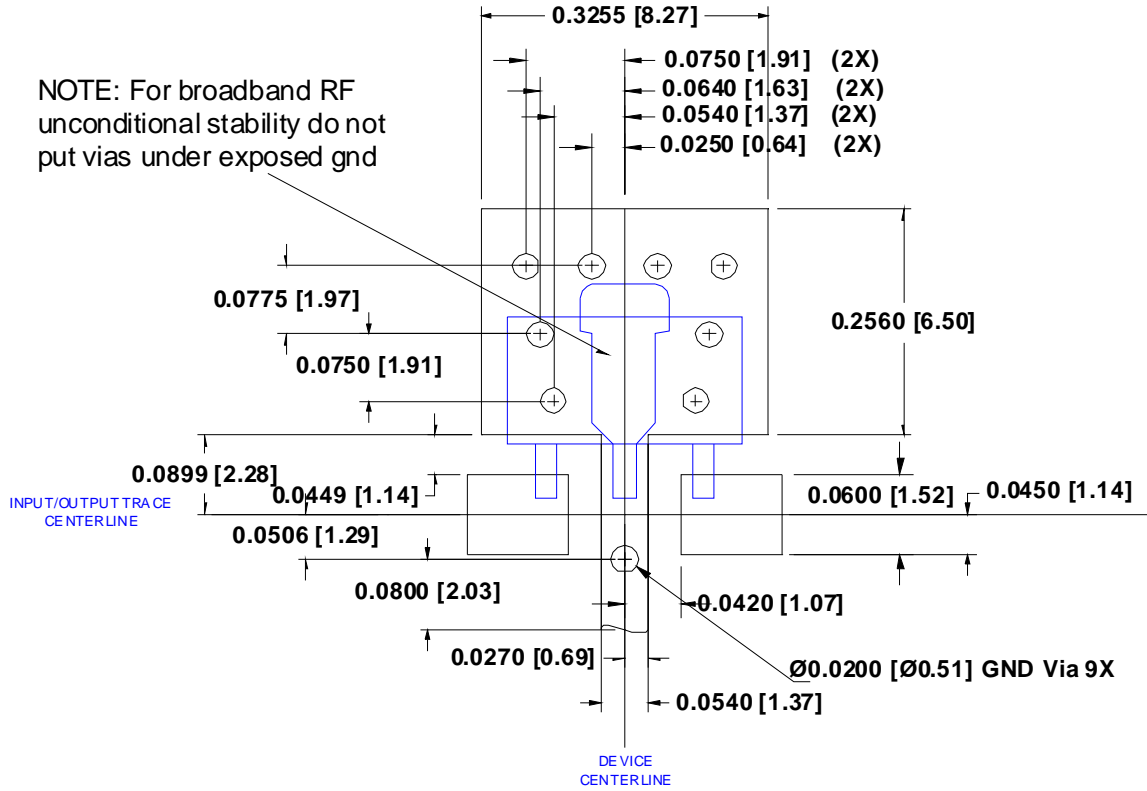

Package Drawing

Dimensions in inches (millimeters)
Refer to drawing posted at www.rfmd.com for tolerances.

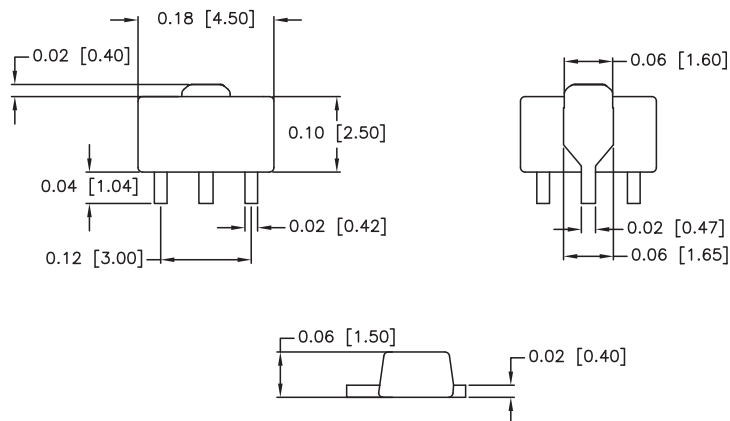

Part Identification.

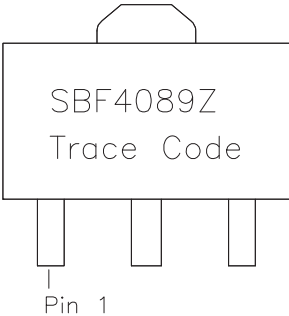

Ordering Information

Ordering Code	Description
SBF4089Z	7" Reel with 1000 pieces
SBF4089ZSQ	Sample bag with 25 pieces
SBF4089ZSR	7" Sample reel with 100 pieces
SBF4089ZPCK1	850MHz, 8V Operation PCBA with 5-piece sample bag