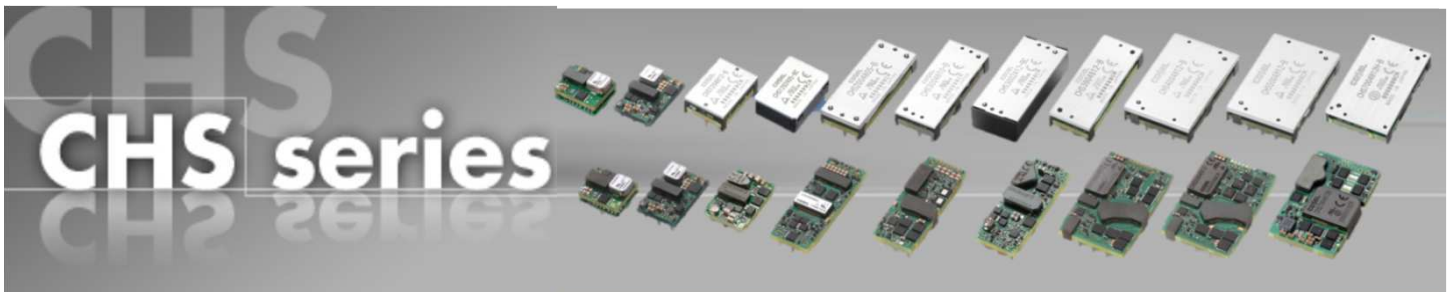


# Applications manual for CHS series



## CHS series

	Page
<b>1. Ordering information</b>	1-1
<b>2. Pin configuration / External view</b>	2-1
2.1 Pin configuration	2-1
2.2 External view	2-3
<b>3. Do's and Don'ts for module</b>	3-1
3.1 Isolation	3-1
3.2 Mounting method	3-1
3.3 Stress onto the pins	3-3
3.4 Cleaning	3-3
3.5 Soldering	3-4
3.6 Safety Standard	3-5
3.7 Automatic Mounting (CHS Series : option "-S")	3-5
3.8 Storage method (CHS Series : option "-S")	3-5
3.9 Stress to the product	3-5
<b>4. Connection method for standard use</b>	4-1
4.1 Connection for standard use	4-1
4.2 Wiring input pin	4-1
4.3 Wiring outpin pin	4-3
<b>5. Overview</b>	5-1
5.1 CHS60	5-1
5.2 CHS80	5-4
5.3 CHS120	5-7
5.4 CHS200	5-16
5.5 CHS300	5-19
5.6 CHS380	5-34
5.7 CHS400	5-37
5.8 CHS500	5-52
5.9 CHS700	5-54
5.10 Derating	5-55
5.11 Input derating	5-79
<b>6. Adjustable voltage range</b>	6-1
6.1 Output voltage adjusting method by external potentiometer	6-1
6.2 Output voltage decreasing by external resistor	6-2
6.3 Output voltage increasing by external resistor	6-2
6.4 Input voltage derating	6-3
<b>7. Protect circuit</b>	7-1
7.1 Overcurrent protection	7-1
7.2 Overvoltage protection	7-1
7.3 Thermal protection	7-1
<b>8. Remote ON/OFF</b>	8-1
<b>9. Remote sensing</b>	9-1
9.1 When the remote sensing function is not in use	9-1
9.2 When the remote sensing function is in use	9-1
<b>10. Series operation / Parallel operation / Redundancy operation</b>	10-1
10.1 Serise operation	10-1
10.2 Parallel operation (CHS400 / CHS500 Series : option "-P")	10-1
10.3 Redundancy operation	10-2
<b>11. SMDtype(option "-S")package information</b>	11-1

# 1. Ordering information

$\frac{\text{CHS}}{\text{①}}$ 
 $\frac{200}{\text{②}}$ 
 $\frac{48}{\text{③}}$ 
 $\frac{05}{\text{④}}$ 
 $\frac{-\square}{\text{⑤}}$

① Series name

CHS : CHS Series

② Output Power

60	80	120	200	300	380	400	500	700
60W	80W	120W	200W	300W	380W	400W	500W	700W

③ Input Voltage

24	48
18V-36V	36V-76V

④ Output Voltage

	CHS60	CHS80	CHS120		CHS200	CHS300		CHS380	CHS400		CHS500	CHS700
			24	48		24	48		24	48		
3.3V	●	●	-	●	●	-	-	-	-	-	-	-
5V	●	●	●	●	●	●	-	-	-	-	-	-
10V	-	-	-	-	-	-	●	●	-	●	-	-
12V	●	●	●	●	●	●	●	●	●	●	●	●
15V	-	-	●	●	-	●	●	-	●	●	-	-
24V	-	-	●	●	-	●	●	-	●	●	-	-
28V	-	-	-	-	-	●	●	-	●	●	-	-
32V	-	-	-	-	-	●	●	-	●	●	-	-
48V	-	-	-	-	-	●	●	-	●	●	-	-

⑤ Option

	CHS60	CHS80	CHS120		CHS200	CHS300		CHS380	CHS400		CHS500	CHS700
			24	48		24	48		24	48		
B	-	-	●※1	●※1	●	●	●	●	●	●	●	●
L2	-	-	●	●	●	●	●	●	●	●	●	●
L5	-	-	●	●	●	●	●	●	●	●	●	●※2
L7	-	-	-	-	-	-	-	-	-	-	-	●
L8	-	-	-	-	-	-	-	-	-	-	-	●
P	-	-	-	-	-	-	-	-	-	●	●	-
R	●	●	●	●	●	●	●	●	●	●	●	●
S	●	●	●	●	-	-	-	-	-	-	-	-
U	●	●	●	●	●	●	●	●	●	●	●	●
BC	-	-	●※3	-	-	●	-	-	●	-	-	-
I	-	-	-	-	-	-	●	-	-	●	●	-

B : Baseplate option with mounting hole M3(※1without mounting hole M3)

L2: Pin length 5.3mm

L5: 5pins type (+S,-S,TRM less) (※2 +S,-S,TRM and outside +Vo,-Vo less)

L7: 7pins type (+S,-S,TRM less)

L8: 8pins type (outside +Vo,-Vo less)

P : Parallel operation (5pins :without +S,-S and TRM)

R : with remote ON/OFF positive logic control

S : SMD

U : Shut down in protection circuit working

BC : Baseplate and case option with mounting hole M3(※3without mounting hole M3)

I : with the PMBus interface(only CHS3004810/4812, CHS4004812, CHS5004812)



## 2. Pin configuration / External view

### 2.1 Pin configuration

Fig.2.1.1  
Pin connection  
for CHS60  
(bottom view)

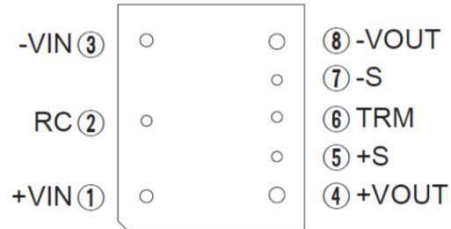


Fig.2.1.2  
Pin connection  
for CHS80  
(bottom view)

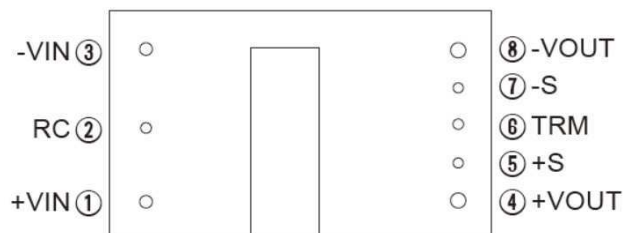


Fig.2.1.3  
Pin connection  
for CHS120  
(bottom view)

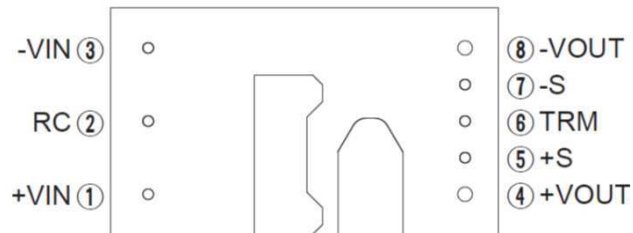


Fig.2.1.4  
Pin connection  
for CHS200  
(bottom view)

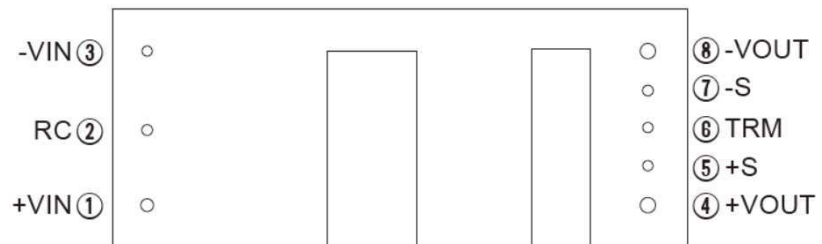


Fig.2.1.5  
Pin connection  
for CHS300  
(bottom view)

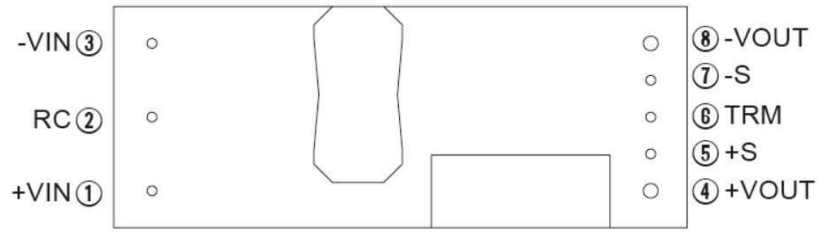


Fig.2.1.6  
Pin connection  
for CHS380  
(bottom view)

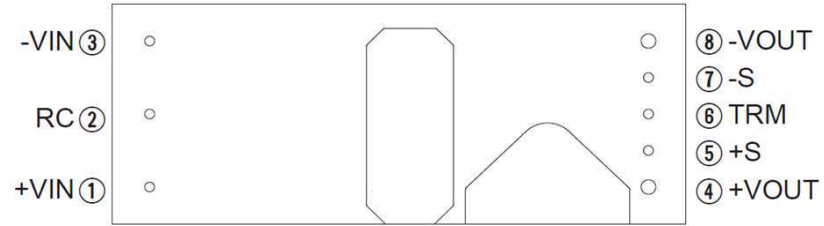


Fig.2.1.7  
Pin connection  
for CHS400 / 500  
(bottom view)

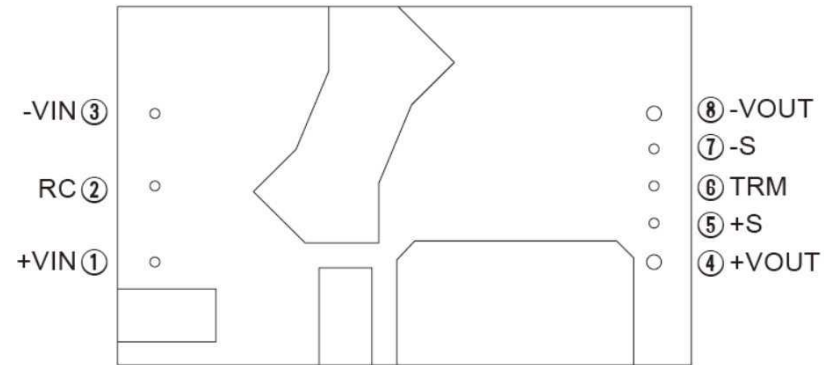


Fig.2.1.8  
Pin connection  
for CHS700  
(bottom view)

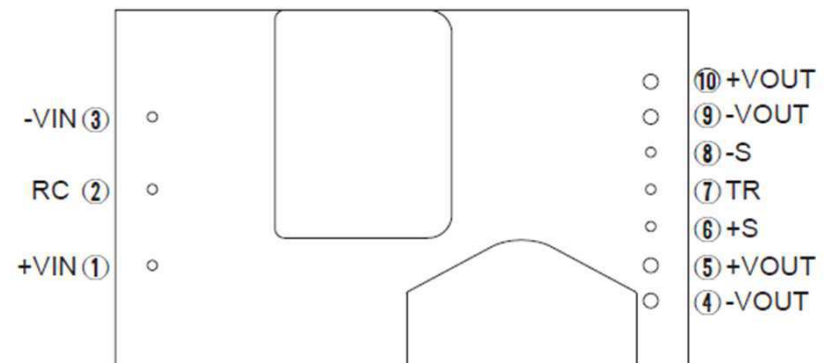


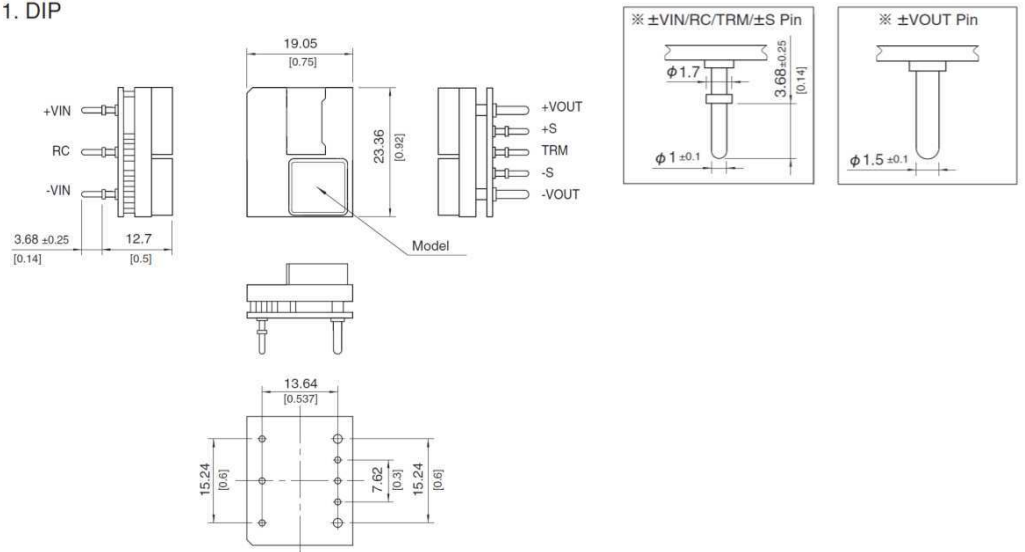
Table.2.1.1  
Pin connection and  
function of CHS

No.		Pin Connection	Function
CHS60, CHS80, CHS120, CHS200, CHS300, CHS380, CHS400, CHS500	CHS700		
①	①	+VIN	+DC input
②	②	RC	Remote ON/OFF
③	③	-VIN	-DC input
④	⑤,⑩	+VOUT	+DC output
⑤	⑥	+S	+Remote sensing
⑥	⑦	TRM	Adjustment of output voltage
⑦	⑧	-S	-Remote sensing
⑧	④,⑨	-VOUT	-DC output

## 2.2 External view

Fig.2.2.1  
External view  
for CHS60

### 1. DIP



### 2. SMD (option "-S")

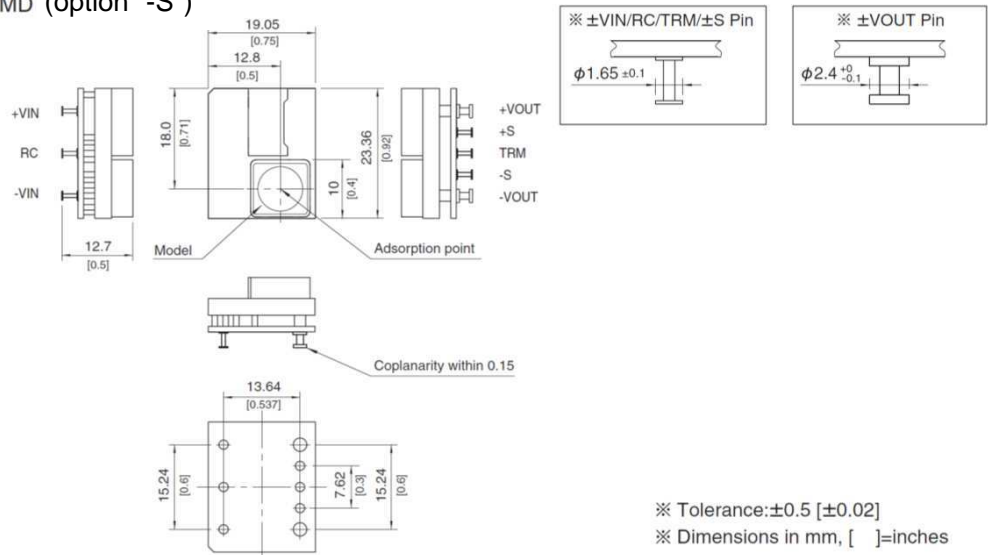
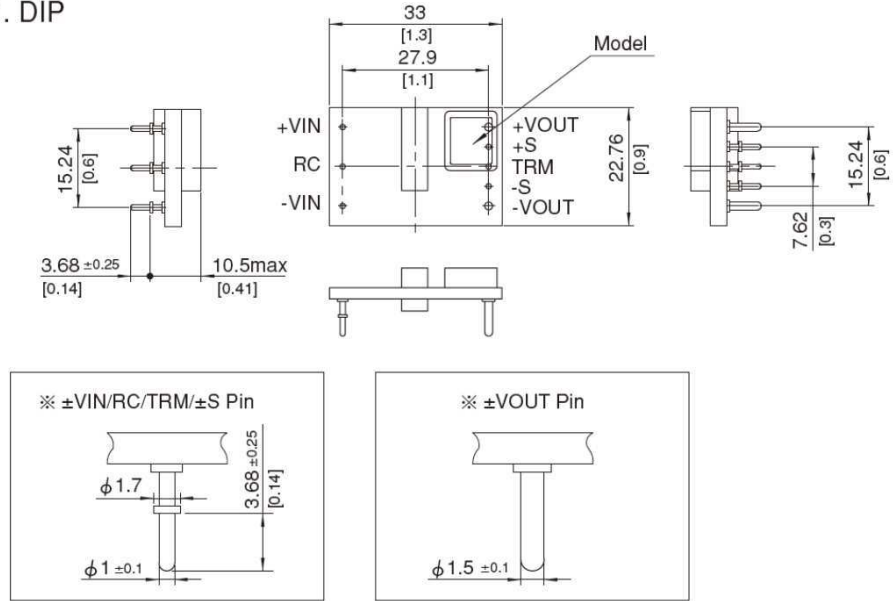


Fig.2.2.2  
External view  
for CHS80

1. DIP



2. SMD (option "-S")

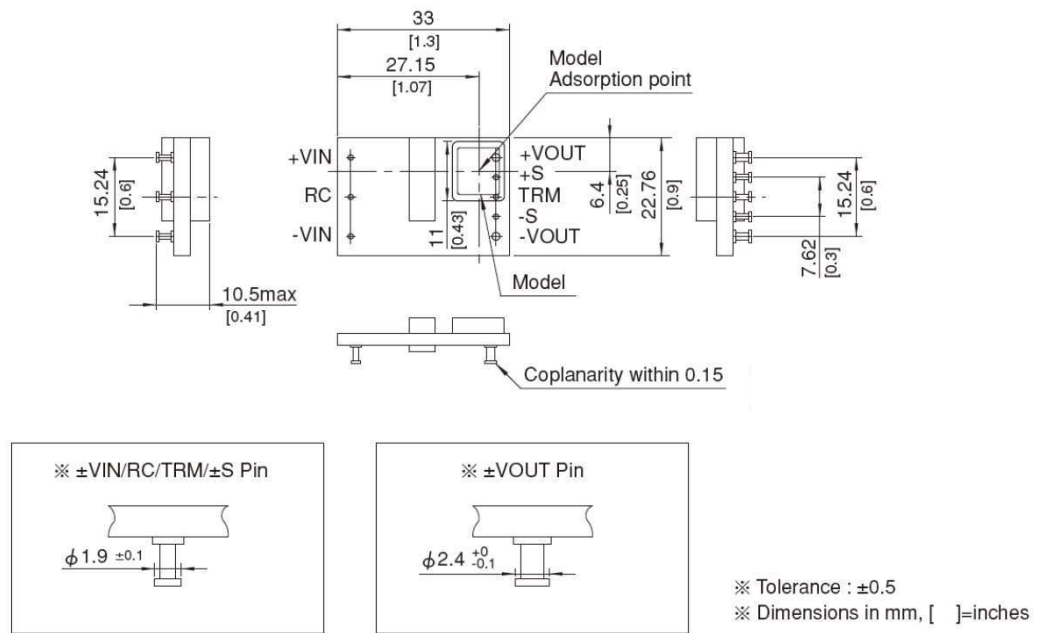
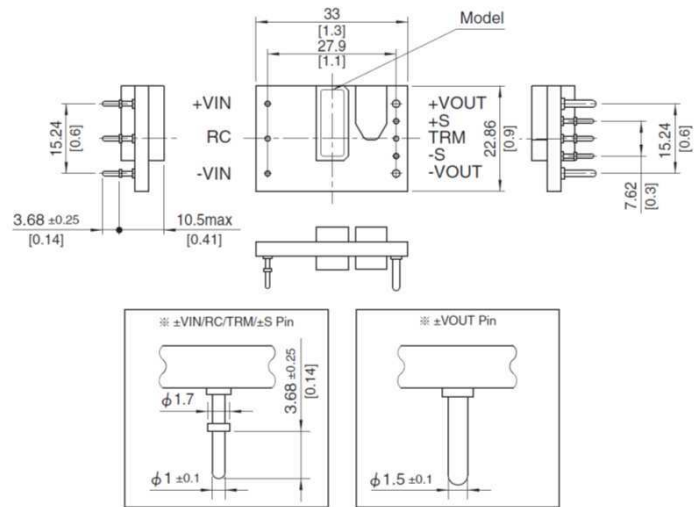
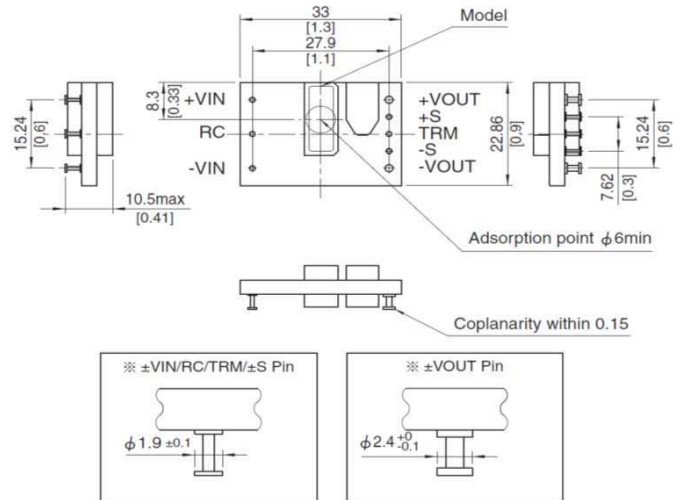


Fig.2.2.3  
External view  
for CHS120

1. DIP

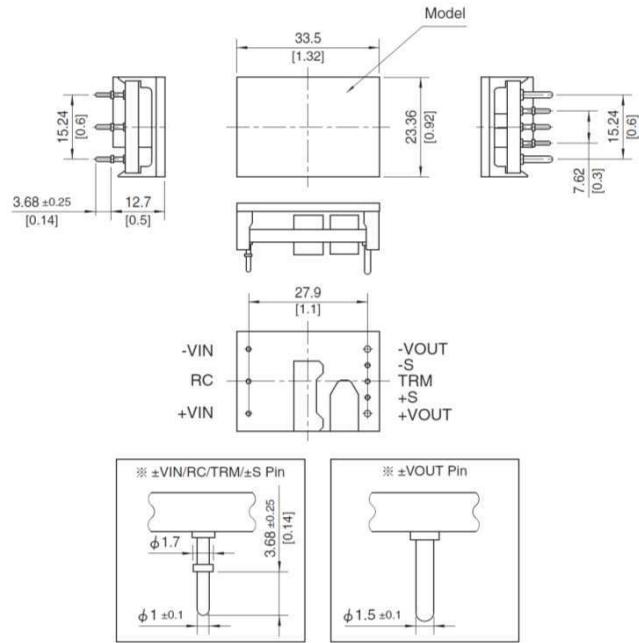


2. SMD (option "-S")

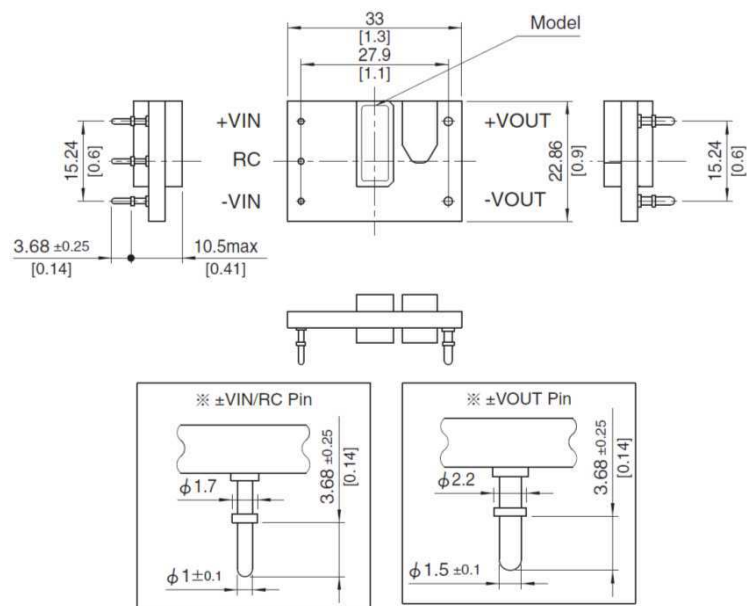


※ Tolerance : ±0.5  
※ Dimensions in mm, [ ]=inches

### 3. BasePlate (option "-B")



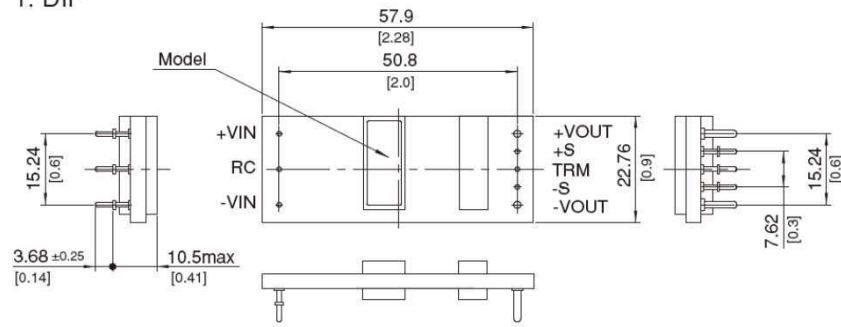
### 4. 5pins type (option "-L5")



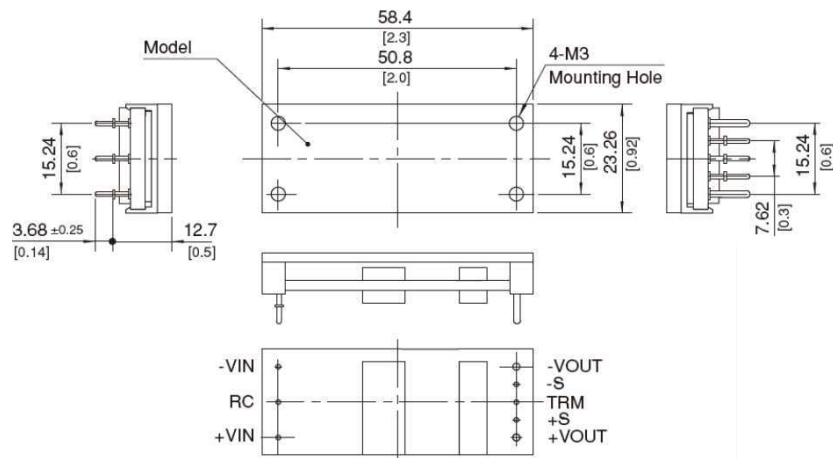
※ Tolerance :  $\pm 0.5$   
 ※ Dimensions in mm, [ ]=inches

Fig.2.2.4  
External view  
for CHS200

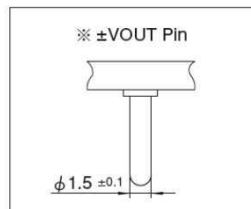
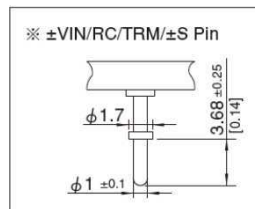
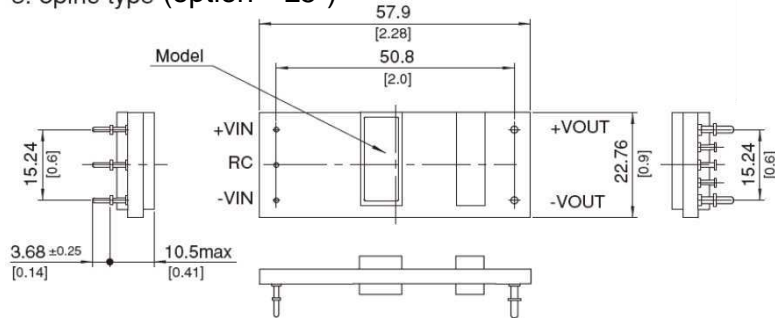
1. DIP



2. BasePlate (option "-B")

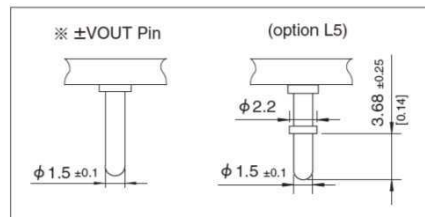
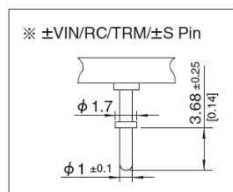
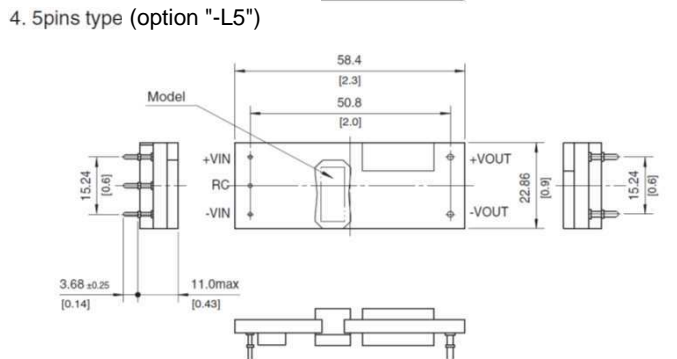
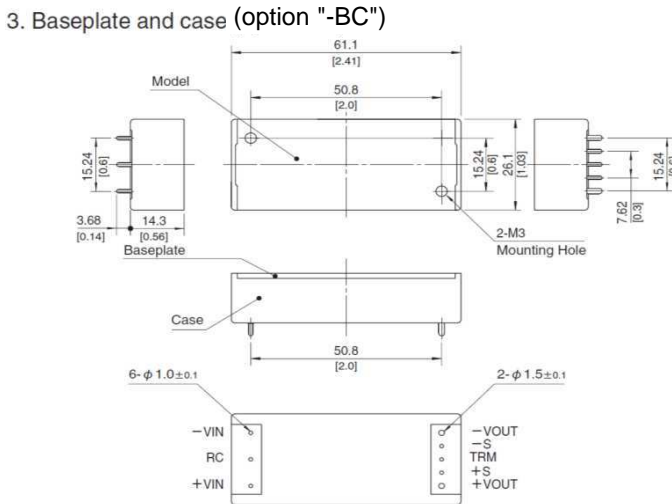
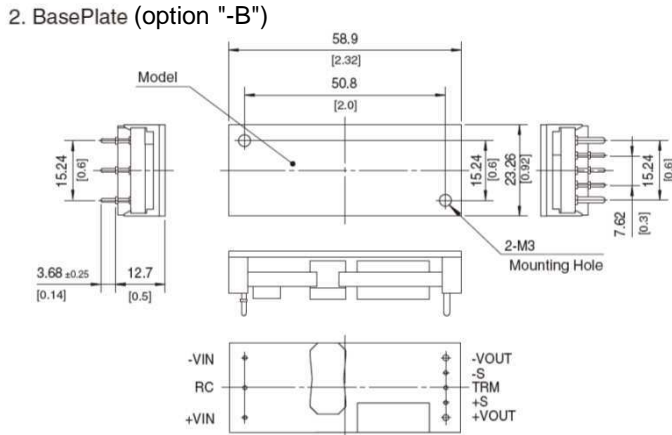
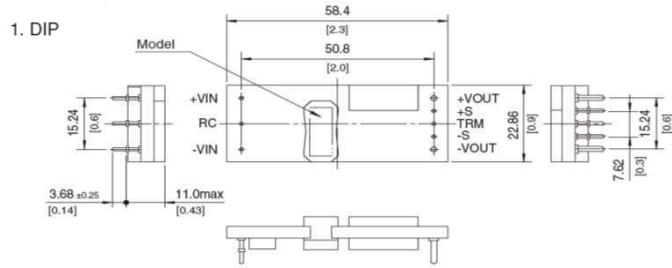


3. 5pins type (option "-L5")



※ Tolerance : ±0.5  
 ※ Dimensions in mm, [ ]=inches

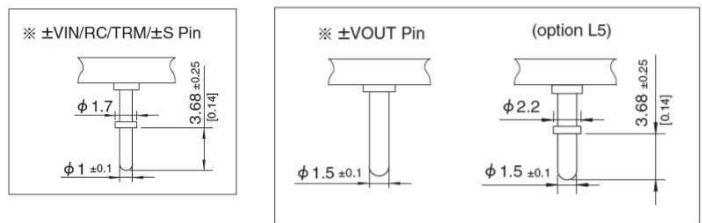
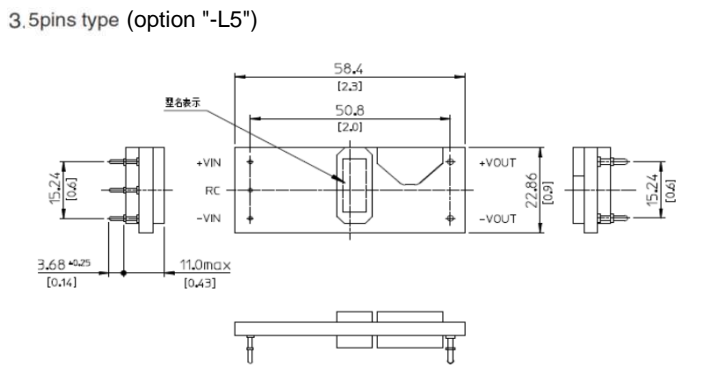
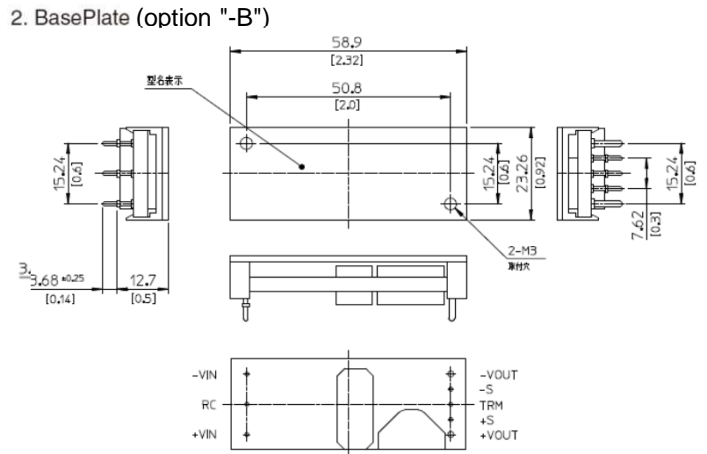
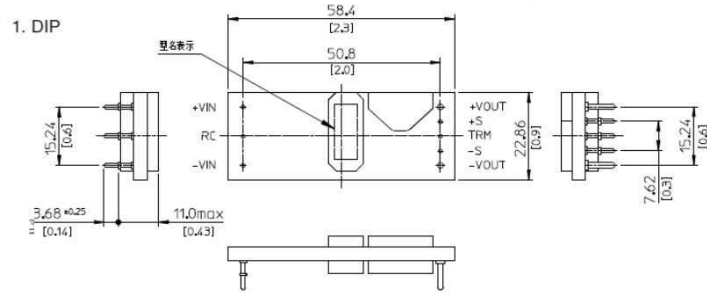
Fig.2.2.5  
External view  
for CHS300



※ Tolerance :  $\pm 0.5$   
 ※ Dimensions in mm, [ ]=inches

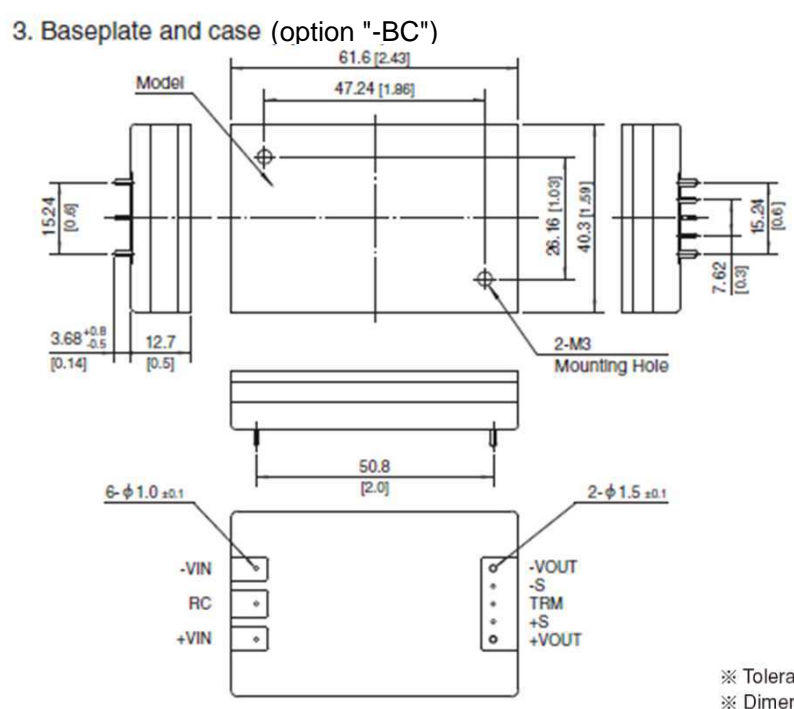
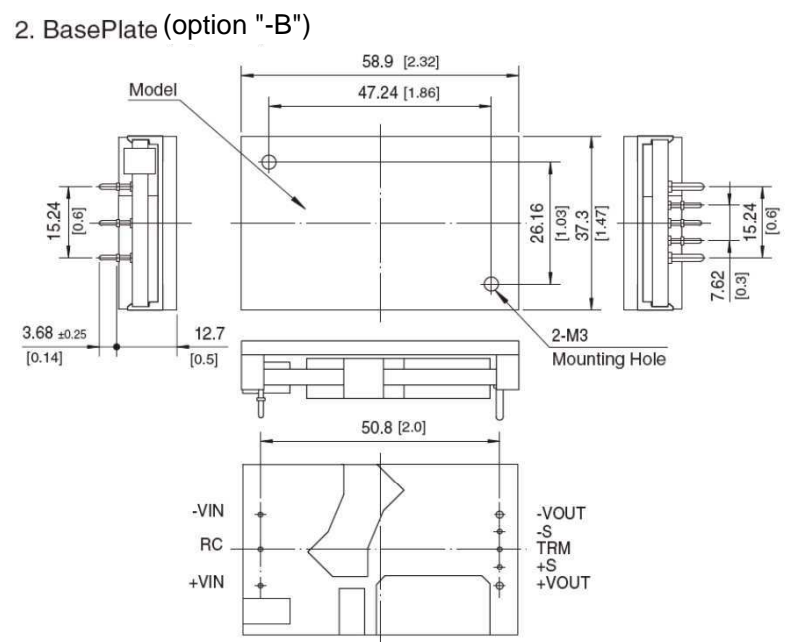
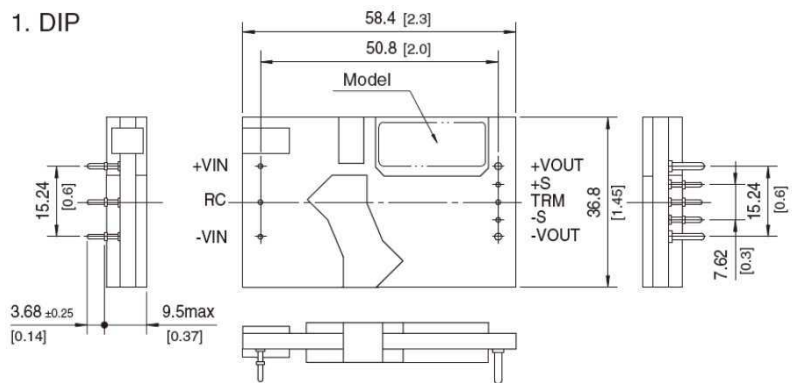


Fig.2.2.6  
External view  
for CHS380



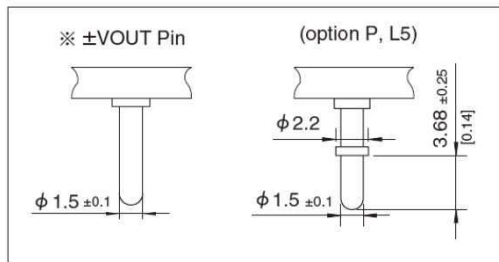
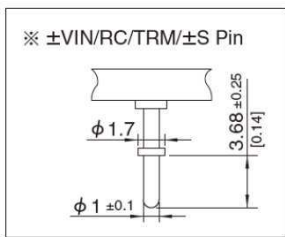
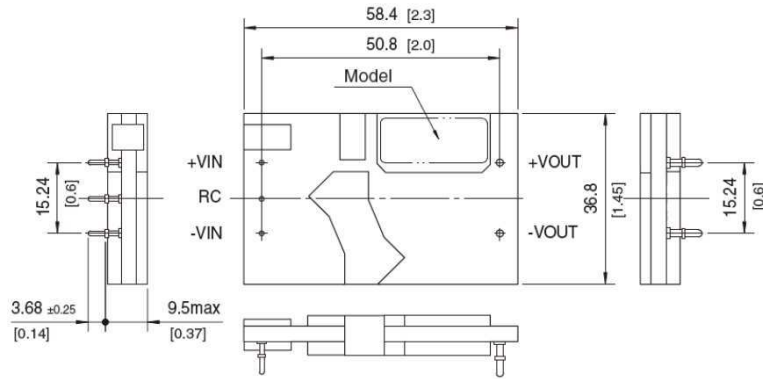
※ Tolerance : ±0.5  
 ※ Dimensions in mm, [ ]=inches

Fig.2.2.7  
External view  
for CHS400 / CHS500



※ Tolerance : ±0.5  
 ※ Dimensions in mm, [ ]=inches

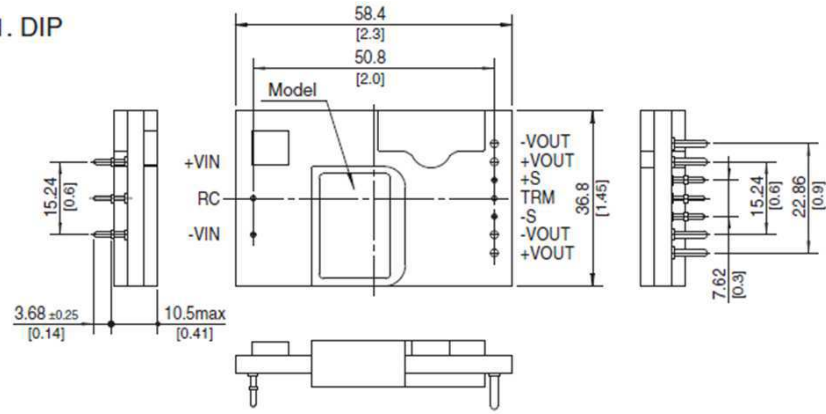
4. Parallel operation (option "-P")  
5pins type (option "-L5")



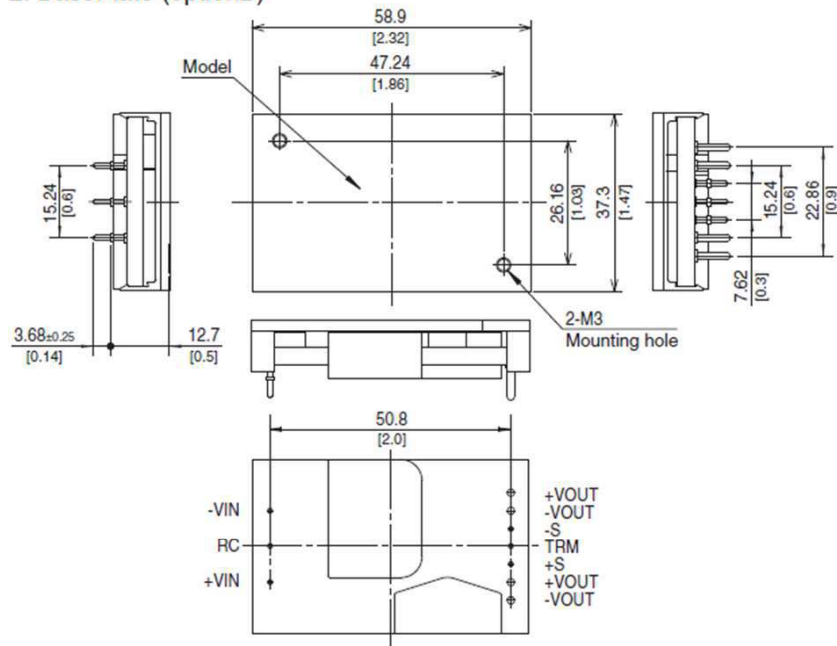
※ Tolerance : ±0.5  
 ※ Dimensions in mm, [ ]=inches

Fig.2.2.8  
External view  
for CHS700

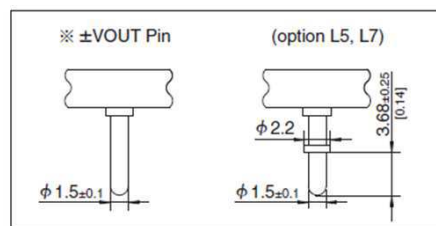
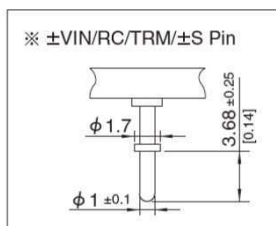
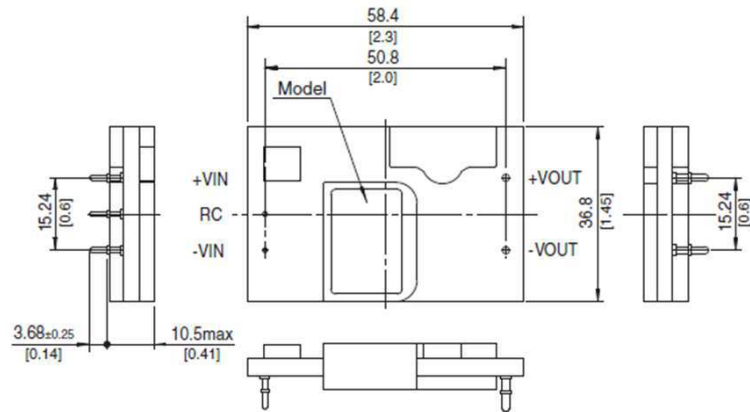
1. DIP



2. BasePlate (optionB)

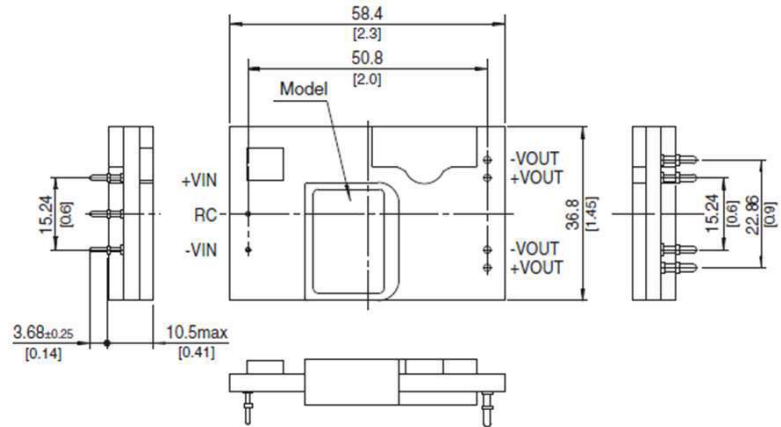


3. 5pins type (option L5)

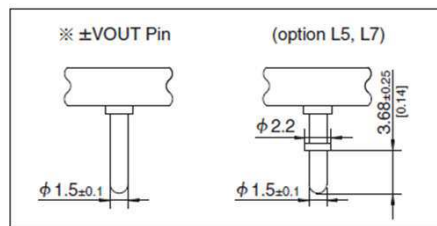
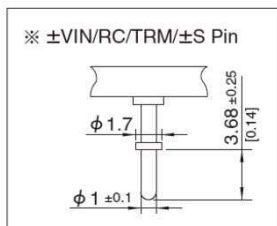
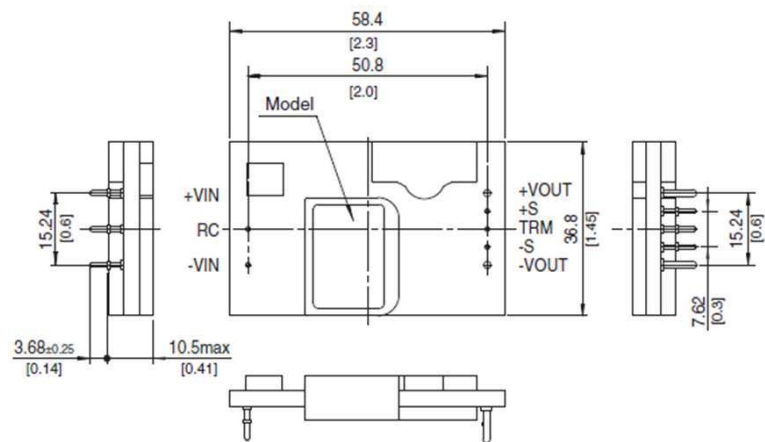


※ Tolerance : ±0.5  
※ Dimensions in mm, [ ]=inches

#### 4. 7pins type (option L7)



#### 5. 8pins type (option L8)



※ Tolerance : ±0.5  
 ※ Dimensions in mm, [ ]=inches

### 3. Do's and Don't for module

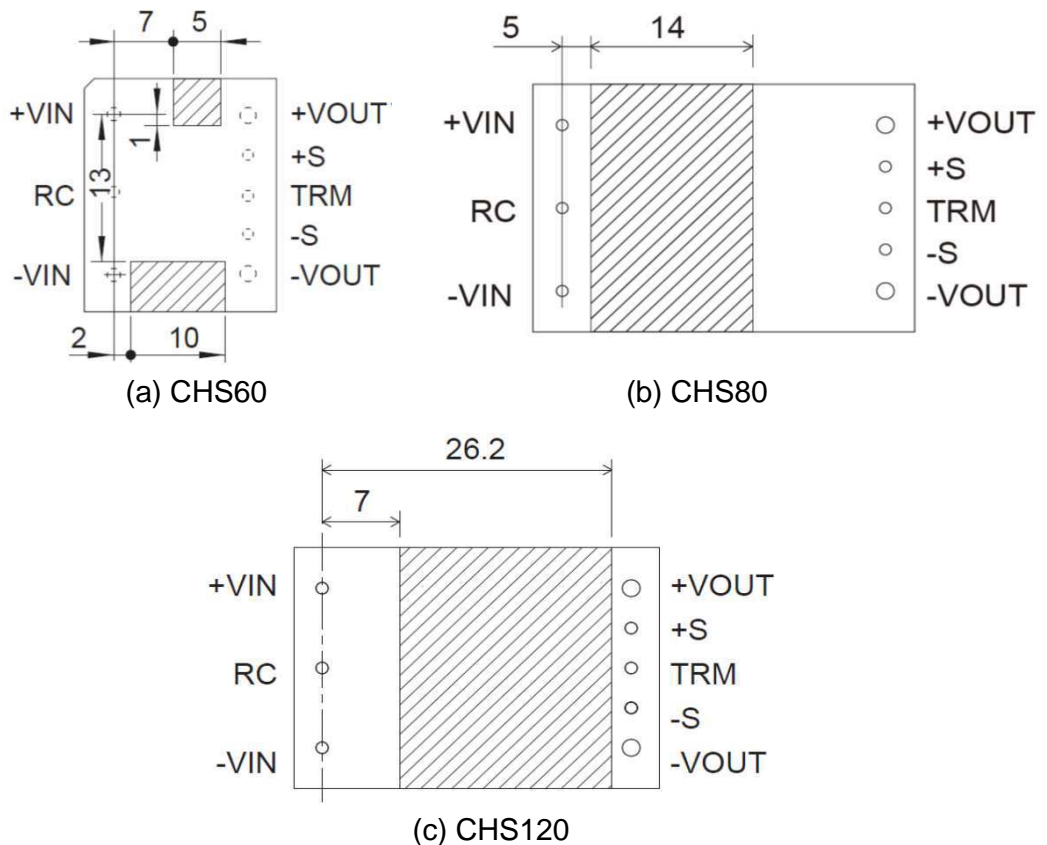
#### 3.1 Isolation

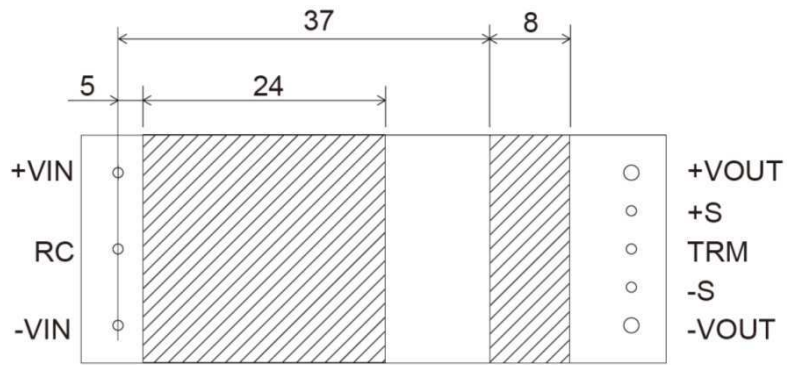
- For a receiving inspection, such as Hi-Pot test, gradually increase(decrease) the voltage for a start (shut down). Avoid using Hi-Pot tester with the timer because it may generate voltage a few times higher than the applied voltage, at ON/OFF of a timer.

#### 3.2 Mounting method

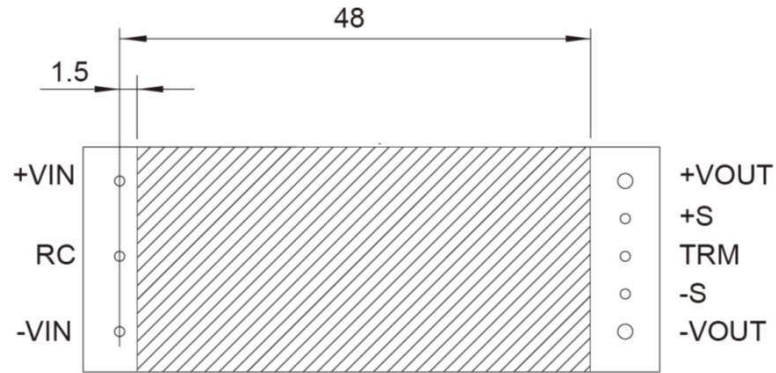
- The unit can be mounted in any direction. When two or more power supplies are used side by side, position them with proper intervals to allow enough air ventilation. The temperature around each power supply should not exceed the temperature range shown in derating curve
- Avoid placing the DC input line pattern layout underneath the unit, it will increase the line conducted noise. Make sure to leave an ample distance between the line pattern layout and the unit. Also avoid placing the DC output line pattern underneath the unit because it may increase the output noise. Lay out the pattern away from the unit.
- Avoid placing the signal line pattern layout underneath the unit, this power supply might become unstable.  
Lay out the pattern away from the unit.
- Avoid placing pattern layout in hatched area in Fig.3.2.1 to insulate between pattern and power supply.

Fig.3.2.1  
Prohibition area of  
Pattern layout(top view)  
Dimension (mm)

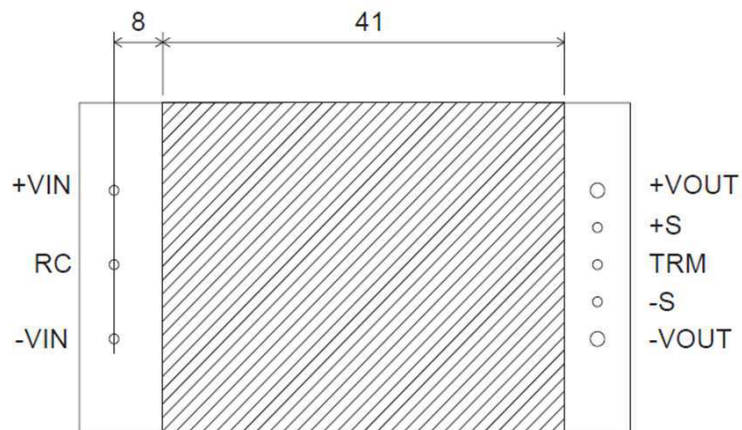




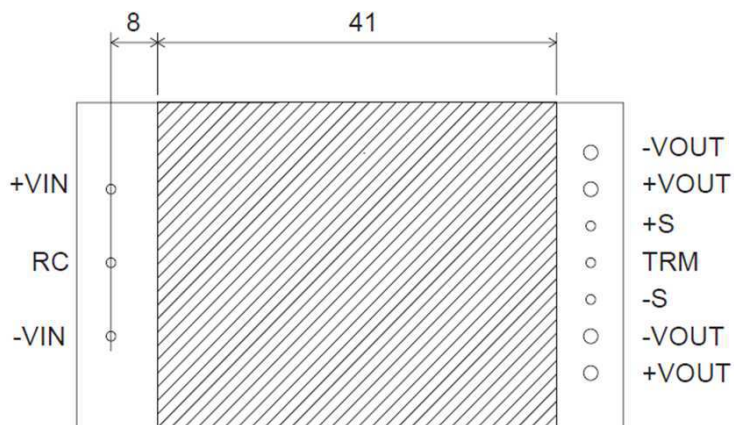
(d) CHS200



(e) CHS300/380



(f) CHS400/CHS500



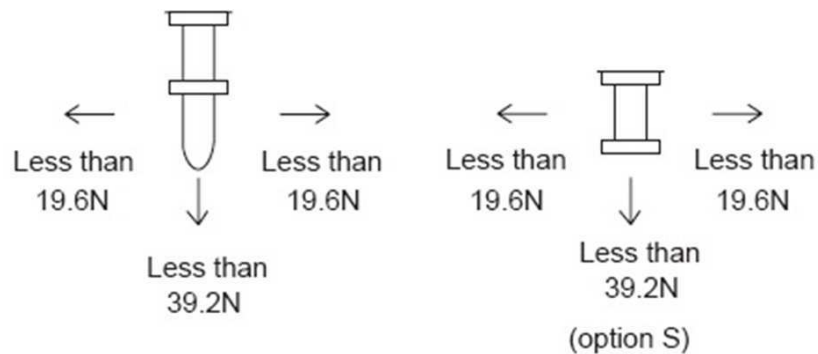
(g) CHS700  
CHS 3-2

### 3.3 Stress onto the pins

---

- When too much stress is applied to the pins of the power supply, the internal connection may be weakened. As shown in Fig.3.3.1, avoid applying stress of more than 19.6N (2kgf) on the pins horizontally and more than 39.2N (4kgf) vertically.
- The pins are soldered on PWB internally, therefore, do not pull or bend them with abnormal forces.
- Fix the unit on PCB (using silicone rubber or fixing fittings) to reduce the stress onto the pins.
- The base plate at Option "B" and "BC" is attached by glue. When fixed to cabinet with screw, fix the power module before soldering the input and output pins to prevent the power module being damaged.

Fig.3.3.1  
Stress to the pins



### 3.4 Cleaning

---

- When cleaning is necessary, clean under the following conditions.
  - Method : Varnishing, ultrasonic wave and vapor
  - Cleaning agents : IPA (Solvent type)
  - Total time : 2 minutes or less
- Do not apply pressure to the lead and name plate with a brush or scratch it during the cleaning.
- After cleaning, dry them enough.



### 3.5 Soldering

- (1) Flow Soldering :260°C 15 seconds or less
- (2) Soldering Iron :maximum 450°C 5 seconds or less
- (3) Reflow Soldering (option "-S")

■ Fig.3.5.1 shows conditions for the reflow soldering for option "-S" of CHS series. Please make sure that the temperatures of pin terminals +VIN and -VOUT shown in Fig.3.5.1 do not exceed the temperatures shown in Fig.3.5.2.

■ If time or temperature of the reflow soldering goes beyond the conditions, reliability of internal components may be compromised. Please use the unit under the recommended reflow conditions.

Fig.3.5.1  
Temperature Measuring  
Points when Setting Reflow  
Soldering Conditions

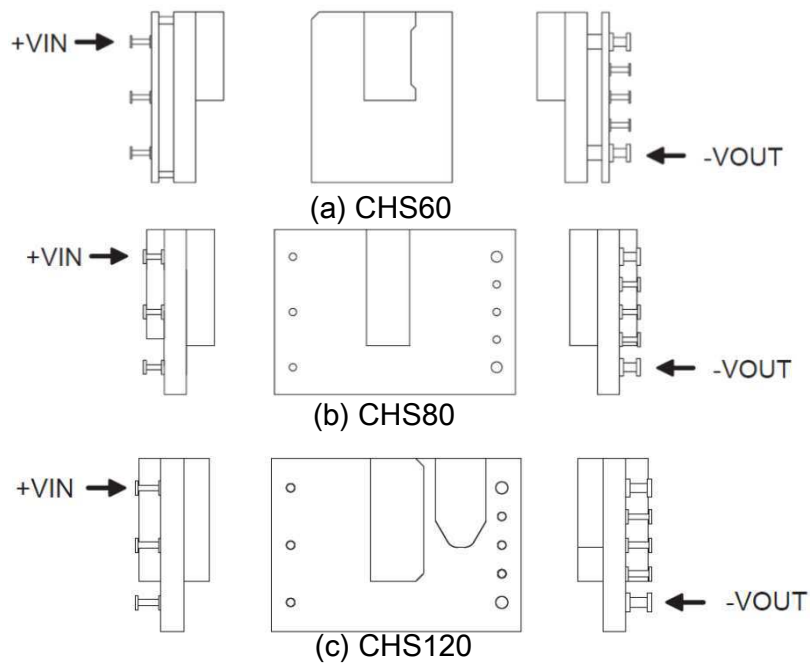
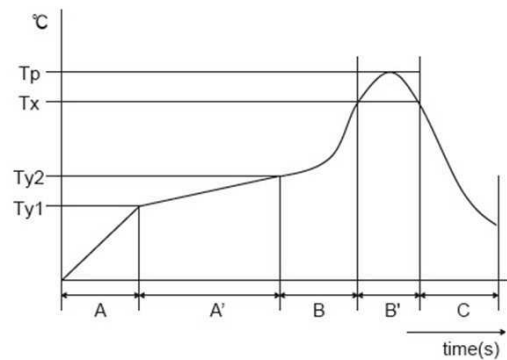


Fig.3.5.2  
Recommend Reflow  
Soldering Conditions



A	1.0 - 5.0°C/s
A'	Ty1:160±10°C Ty2:180±10°C Ty1 - Ty2:120s max
B	1.0 - 5.0°C/s
B'	Tp:Max245°C 10s max Tx:220°C or more:70s max
C	1.0 - 5.0°C/s

- Notes to use option "-S"

- Solder iron or other similar methods are not recommended soldering method for option "-S" because it may not be able to retain connection reliability between the PCB and the Pins. Solder reflow is the acceptable mounting system for the option.
- Option "-S" is not reusable product after soldered on any application PCB.

### 3.6 Safety standard

---

- To apply for safety standard approval using this power supply, the following conditions must be met.
- This unit must be used as a component of the end-use equipment.
- The equipment must contain basic insulation between input and output. If double or reinforced insulation is required, it has to be provided by the end-use equipment in accordance with the final build-in condition.
- Safety approved fuse must be externally installed on input side.

### 3.7 Automatic Mounting (CHS series : option "-S")

---

- To mount CHS series automatically, use the coil area near the center of the PCB as an adsorption point. Please see the External View for details of the adsorption point. If the bottom dead point of a suction nozzle is too low when mounting excessive force is applied to the coil, it could cause damage. Please mount carefully.

### 3.8 Storage method (CHS series : option "-S")

---

- To stock unpacked products in your inventory, it is recommended to keep them under controlled condition, 5-30°C, 60%RH and use them within a year.
- 24-hour baking is recommended at 125°C, if unpacked products were kept under uncontrolled condition, which is 30°C, 60%RH or higher. Original trays are not heat-resistant. Please move them to heat-resistant trays in preparation to bake. To check moisture condition in the pack. Silica gel packet has some moisture condition indicator particles. Indicated blue means good. Pink means alarm to bake it.
- Notification. The tray will be deformed and the power supply might be damaged, if the vacuum pressure is too much to reseal.

### 3.9 Stress to the product

---

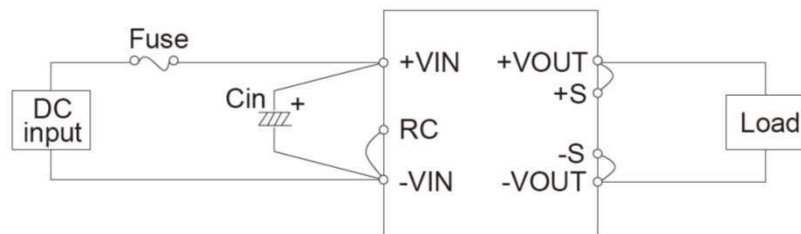
- CHS series transformer core and choke coil are attached by glue. There is a possibility that the core will be removed and power supply will be damaged when they receive stress by the fall or some kind of stress.
- The base plate at Option "B" and "BC" is attached by glue. There is a possibility that the base plate will be removed and power supply will be damaged when they receive stress by the fall or some kind of stress.

## 4. Connection method for standard use

### 4.1 Connection for standard use

- In order to use the power supply, it is necessary to wire as shown in Fig.4.1.1
- Short the following pins to turn on the power supply.  
-VIN ⇔ RC, +VOUT ⇔ +S, -VOUT ⇔ -S
- The CHS series handle only the DC input.  
Avoid applying AC input directly.  
It will damage the power supply.

Fig.4.1.1  
Connection for  
standard use of CHS



Cin : External capacitor on the input side

### 4.2 Wiring input pin

#### (1) External fuse

- Fuse is not built-in on input side. In order to protect the unit, install the normal-blow type fuse on input side.
- When the input voltage from a front end unit is supplied to multiple units, install the normal-blow type fuse in each unit.

Table.4.2.1  
Recommended fuse  
(Normal-blow type)

Model Input voltage [V]	CHS60	CHS80	CHS120	CHS200	CHS300
24	-	-	15A	-	20A (05/10/12/15) 30A (24/28/32/48)
48	5A	7A	10A	15A	15A
Model Input voltage [V]	CHS380	CHS400	CHS500	CHS700	
24	-	40A	-	-	
48	20A	20A	30A	30A	

(2) External capacitor on the input side

- Install an external capacitor  $C_{in}$ , between +VIN and -VIN input pins for low line-noise and for stable operation of the power supply.

Table.4.2.2  
Recommended  
external input capacitor  
(Ceramic)

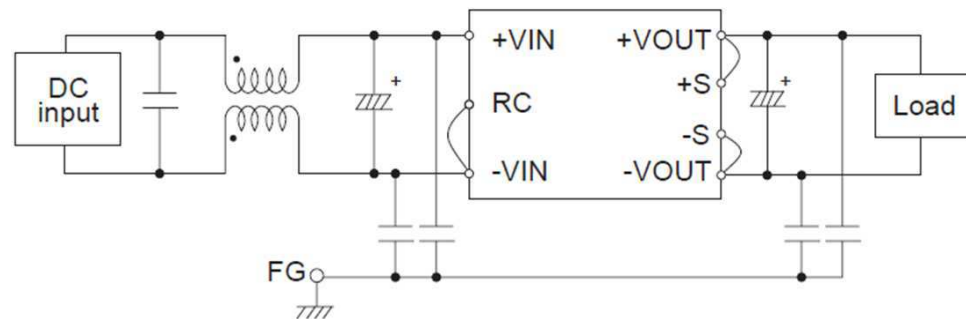
Model	CHS12024		CHS30024		CHS40024	
$C_{in}$	220 $\mu$ F or more		660 $\mu$ F or more		660 $\mu$ F or more	
Model	CHS6048	CHS8048	CHS12048	CHS20048		
$C_{in}$	66 $\mu$ F or more	33 $\mu$ F or more	47 $\mu$ F or more	100 $\mu$ F or more		
Model	CHS30048/CHS38048/CHS40048/CHS50048				CHS70048	
$C_{in}$	200 $\mu$ F or more				400 $\mu$ F or more	

- Capacitance Refer to Table.4.2.2  
 $T_a = -20$  to  $+85^\circ\text{C}$  Electrolytic or Ceramic capacitor  
 $T_a = -40$  to  $+85^\circ\text{C}$  Ceramic capacitor
- $C_{in}$  is within 50mm for pins. Make sure that ripple current of  $C_{in}$  is less than its rating.

(3) Recommendation for noise-filter

- Install an external input filter as shown in Fig.4.2.1 in order to reduce conducted noise.  $C_{in}$  is shown in Table.4.2.2

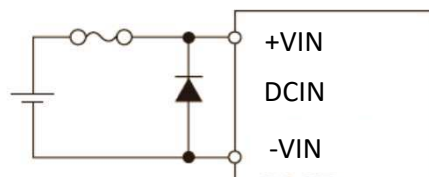
Fig.4.2.1  
Example of  
recommended external  
input filter



(4) Reverse input voltage protection

- Avoid the reverse polarity input voltage. It will damage the power supply. It is possible to protect the unit from the reverse input voltage by installing an external diode as shown in Fig.4.2.2.

Fig.4.2.2  
Reverse input voltage  
protection



### 4.3 Wiring output pin

- When the CHS series supplies the pulse current for the pulse load, please install a capacitor  $C_o$  between +VOUT and -VOUT pins.  
Recommended capacitance of  $C_o$  is shown in Table 4.3.1, 4.3.2.
- If output current decreases rapidly, output voltage rises transiently and the overvoltage protection circuit may operate.  
In this case, please install a capacitor  $C_o$ .
- Select a high frequency type capacitor. Output ripple and startup waveform may be influenced by ESR-ESL of the capacitor and the wiring impedance.
- Make sure that ripple current of  $C_o$  is than its rating.

Table.4.3.1  
Recommended capacitance  $C_o$   
(CHS60, CHS80, CHS120,  
CHS200, CHS30024, CHS380)

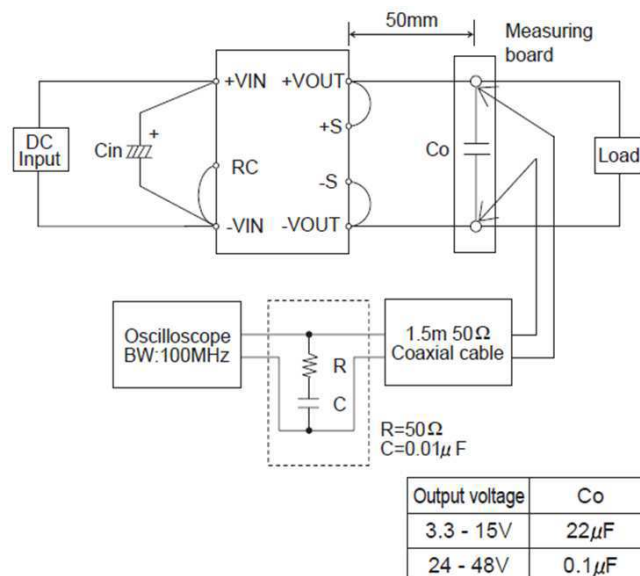
No.	Output voltage	CHS60	CHS80	CHS120	CHS200/ CHS30024/ CHS380
1	3.3V	0 - 20,000 $\mu$ F	0 - 20,000 $\mu$ F	0 - 20,000 $\mu$ F	0 - 40,000 $\mu$ F
2	5V	0 - 10,000 $\mu$ F	0 - 10,000 $\mu$ F	0 - 10,000 $\mu$ F	0 - 20,000 $\mu$ F
3	10V	-	-	-	0 - 2,200 $\mu$ F
4	12V	0 - 2,200 $\mu$ F	0 - 1,000 $\mu$ F	0 - 2,200 $\mu$ F	0 - 2,200 $\mu$ F
5	15V	-	-	0 - 2,200 $\mu$ F	0 - 2,200 $\mu$ F
6	24V	-	-	0 - 1,000 $\mu$ F	0 - 2,200 $\mu$ F
7	28V	-	-	-	0 - 2,200 $\mu$ F
8	32V	-	-	-	0 - 2,200 $\mu$ F
9	48V	-	-	-	0 - 1,000 $\mu$ F

Table.4.3.2  
Recommended capacitance  $C_o$   
(CHS30048, CHS40024,  
CHS40048, CHS500, CHS700)

No.	Output voltage	CHS30048	CHS40024	CHS40048/ CHS500	CHS700
1	10V	0 - 2,200 $\mu$ F	-	0 - 4,000 $\mu$ F	-
2	12V	0 - 2,200 $\mu$ F	0 - 4,000 $\mu$ F	0 - 4,000 $\mu$ F	0 - 10,000 $\mu$ F
3	15V	0 - 2,200 $\mu$ F	0 - 4,000 $\mu$ F	0 - 4,000 $\mu$ F	-
4	24V	0 - 2,200 $\mu$ F	0 - 3,300 $\mu$ F	0 - 3,300 $\mu$ F	-
5	28V	0 - 1,000 $\mu$ F	0 - 3,300 $\mu$ F	0 - 3,300 $\mu$ F	-
6	32V	0 - 1,000 $\mu$ F	0 - 3,300 $\mu$ F	0 - 3,300 $\mu$ F	-
7	48V	0 - 1,000 $\mu$ F	0 - 2,200 $\mu$ F	0 - 1,000 $\mu$ F	-

- Ripple and Ripple Noise are measured, as shown in the Fig.4.3.1.  
 $C_{in}$  is shown in Table 4.2.2.

Fig.4.3.1  
Measuring method of  
Ripple and Ripple Noise

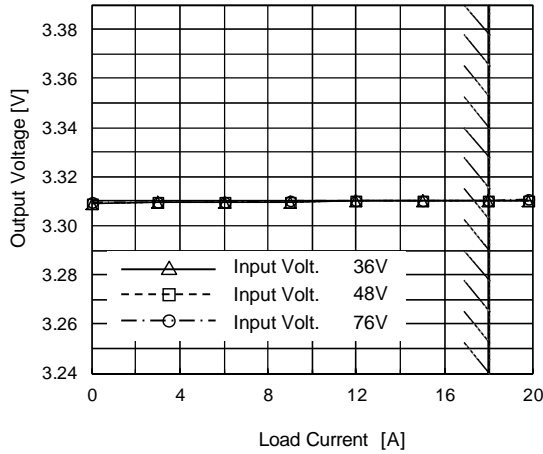


# 5. Overview

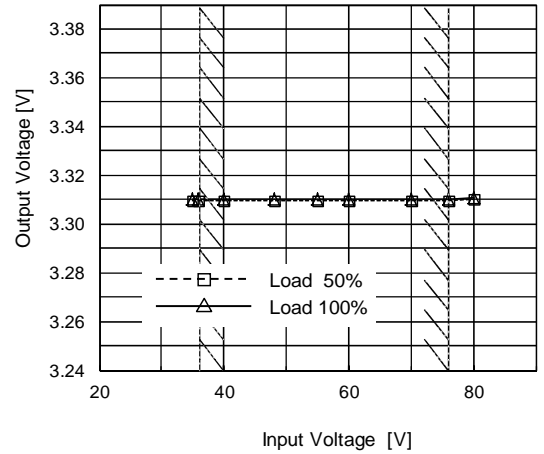
## 5.1 CHS60

### 5.1.1 CHS60483R3

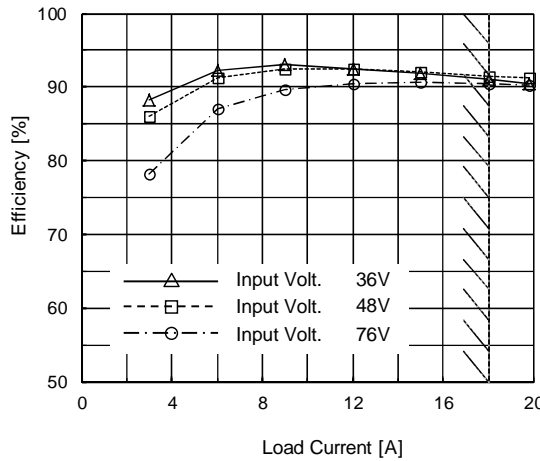
Fig.5.1.1  
Overview of  
CHS60483R3 at 25°C



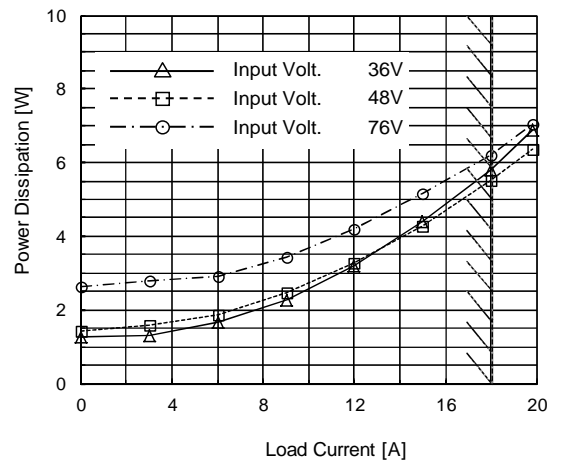
(a) Load Regulation



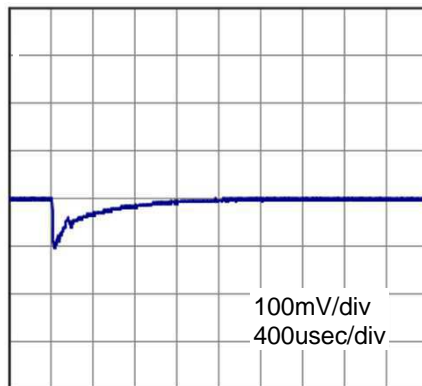
(b) Line Regulation



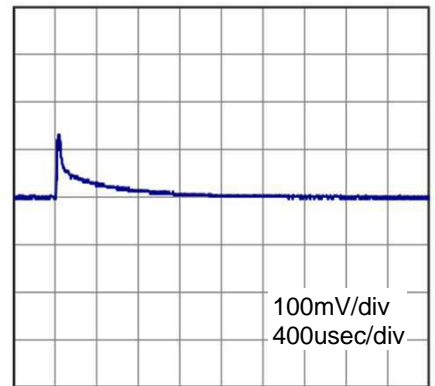
(c) Efficiency (by Load Current)



(d) Power Dissipation (by Load Current)



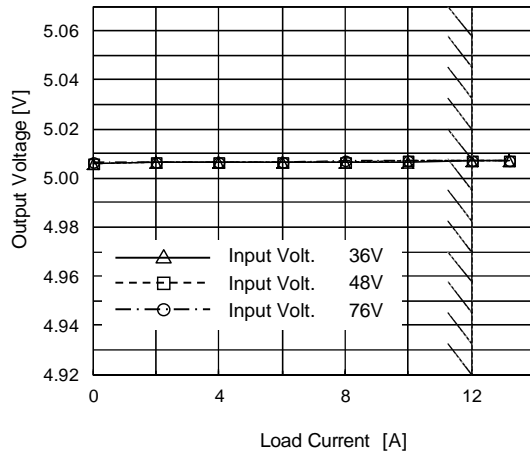
(e) Dynamic Load Response  
Load 50%(9A)→Load 100%(18A)/50us  
Vin 48V, Vout 3.3V



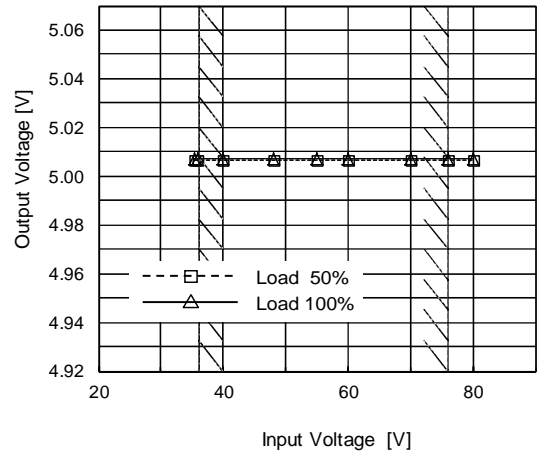
(f) Dynamic Load Response  
Load 100%(18A)→Load 50%(9A)/50us  
Vin 48V, Vout 3.3V

## 5.1.2 CHS604805

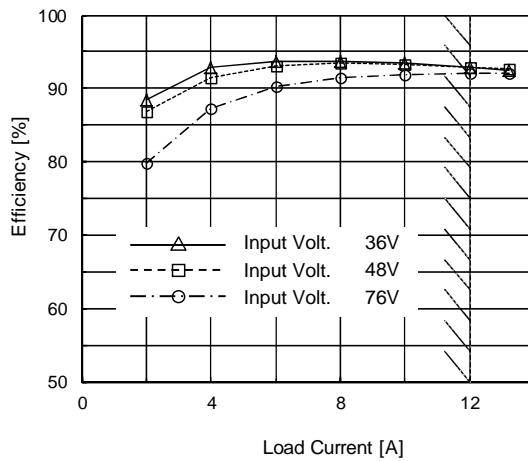
Fig.5.1.2  
Overview of  
CHS604805 at 25°C



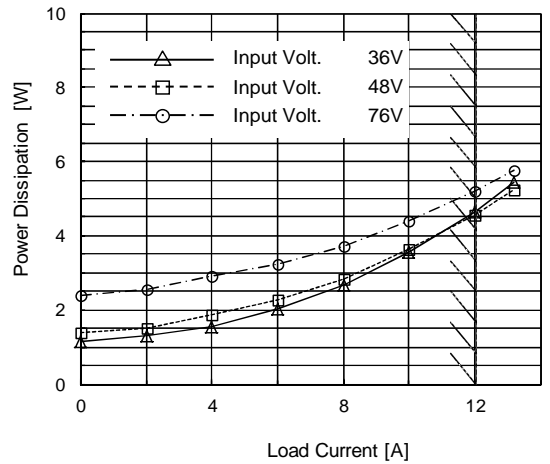
(a) Load Regulation



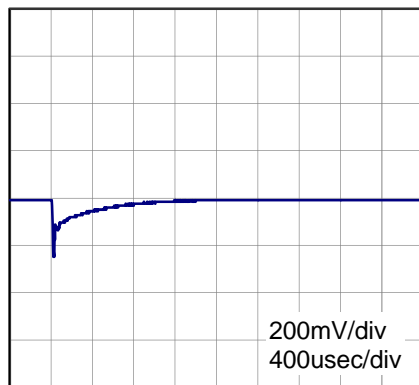
(b) Line Regulation



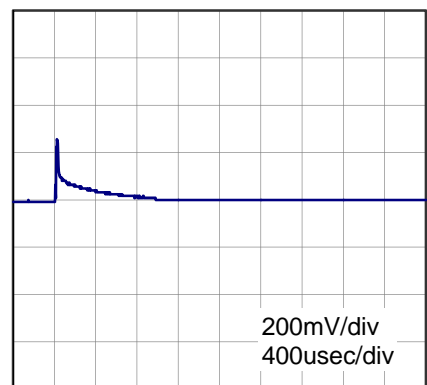
(c) Efficiency (by Load Current)



(d) Power Dissipation (by Load Current)



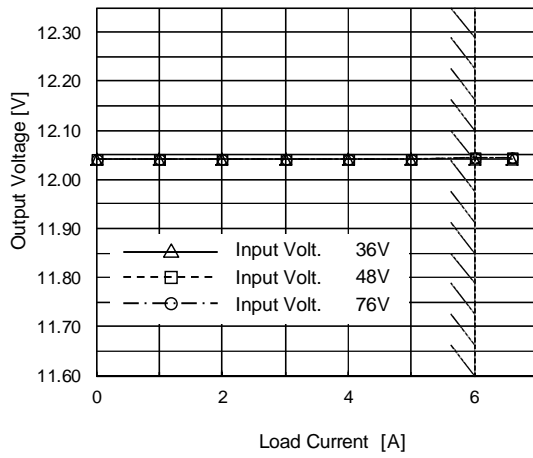
(e) Dynamic Load Response  
Load 50%(6A)→Load 100%(12A)/50us  
Vin 48V, Vout 5.0V



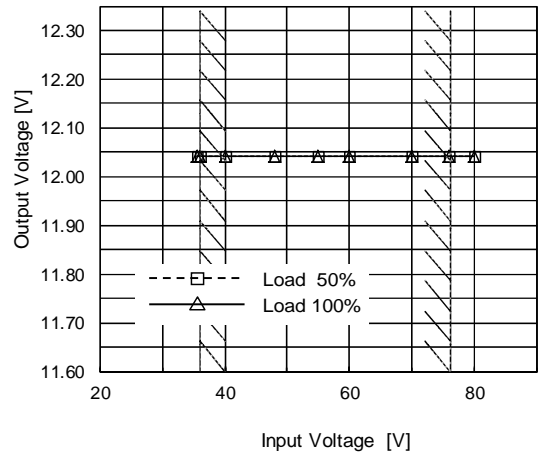
(f) Dynamic Load Response  
Load 100%(12A)→Load 50%(6A)/50us  
Vin 48V, Vout 5.0V

### 5.1.3 CHS604812

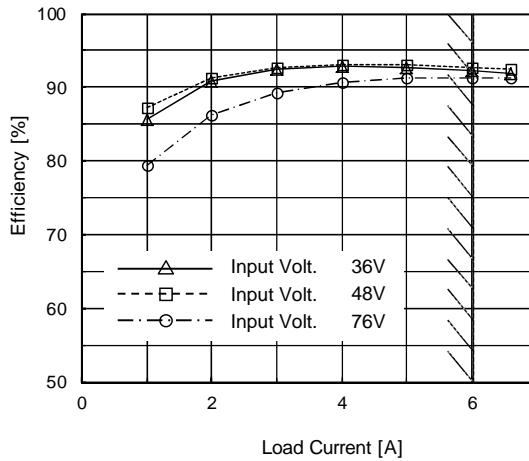
Fig.5.1.3  
Overview of  
CHS604812 at 25°C



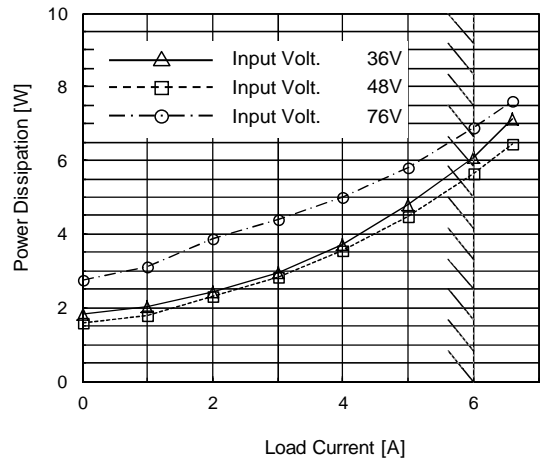
(a) Load Regulation



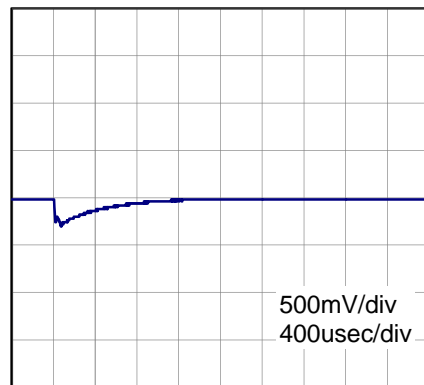
(b) Line Regulation



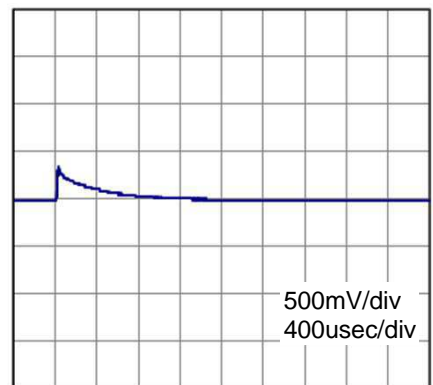
(c) Efficiency (by Load Current)



(d) Power Dissipation (by Load Current)



(e) Dynamic Load Response  
Load 50%(3A)→Load 100%(6A)/50us  
Vin 48V, Vout 12V



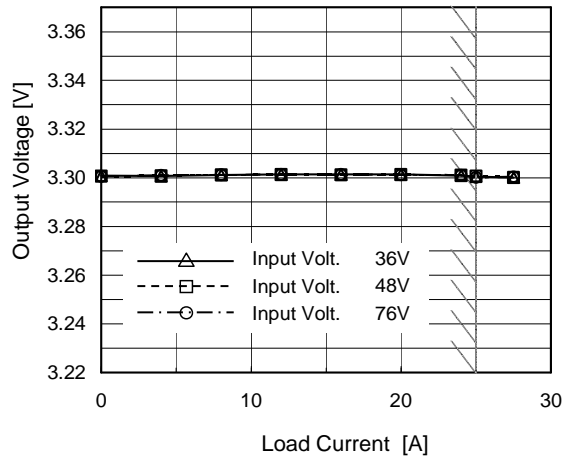
(f) Dynamic Load Response  
Load 100%(6A)→Load 50%(3A)/50us  
Vin 48V, Vout 12V



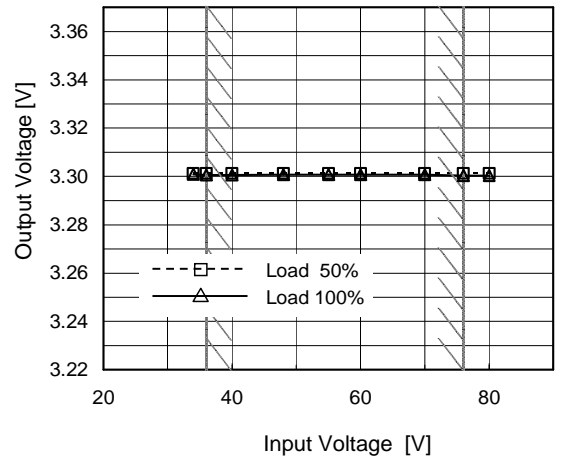
## 5.2 CHS80

### 5.2.1 CHS80483R3

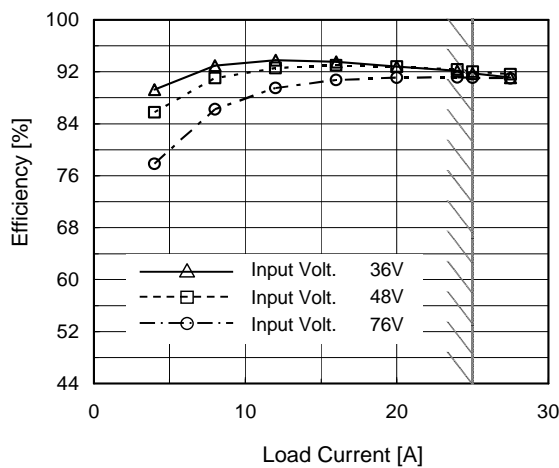
Fig.5.2.1  
Overview of  
CHS80483R3 at 25°C



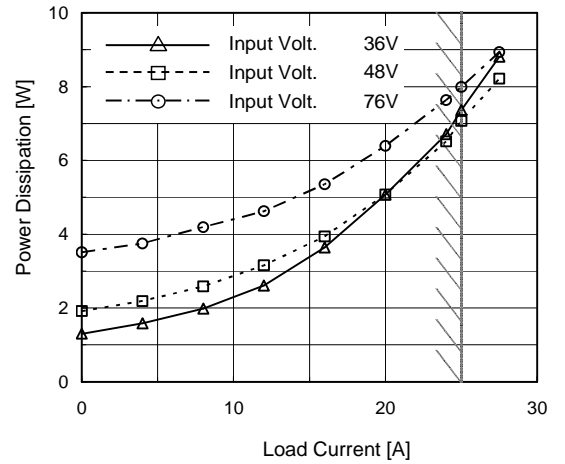
(a) Load Regulation



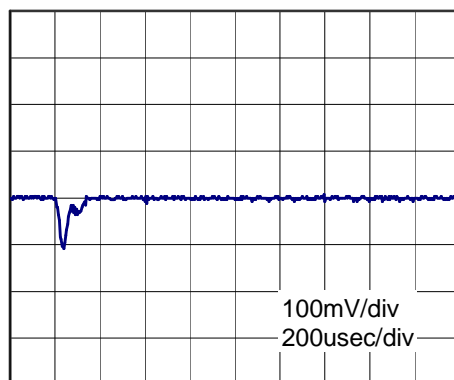
(b) Line Regulation



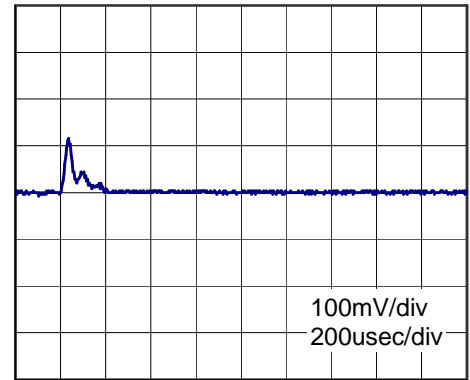
(c) Efficiency ( by Load Current )



(d) Power Dissipation( by Load Current )



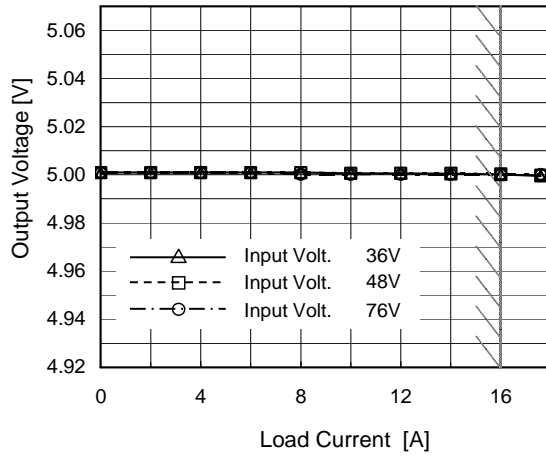
(e) Dynamic Load Response  
Load 50%(12.5A)→Load 100%(25A) / 50µs  
Vin 48V, Vout 3.3V



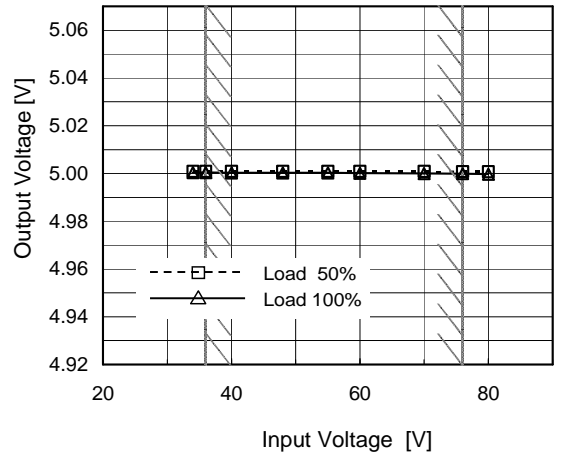
(f) Dynamic Load Response  
Load 100%(25A)→Load 50%(12.5A) / 50µs  
Vin 48V, Vout 3.3V

## 5.2.2 CHS804805

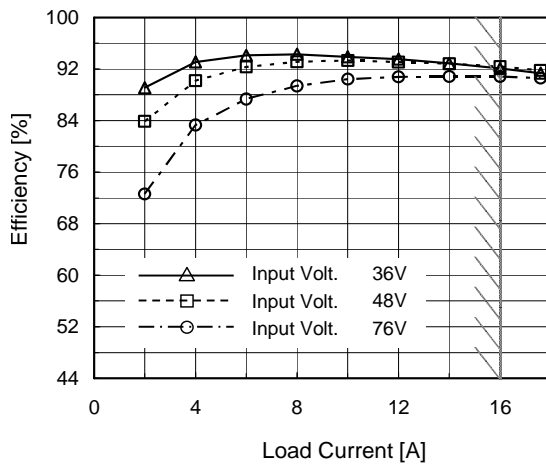
Fig.5.2.2  
Overview of  
CHS804805 at 25°C



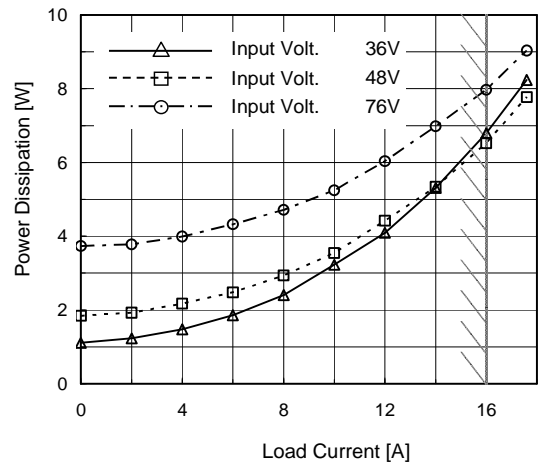
(a) Load Regulation



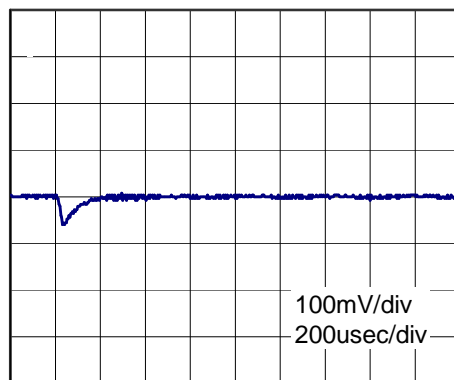
(b) Line Regulation



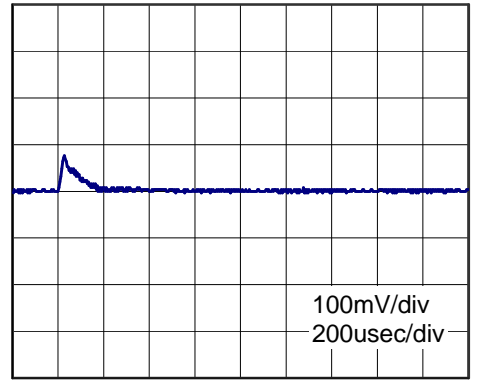
(c) Efficiency (by Load Current)



(d) Power Dissipation (by Load Current)



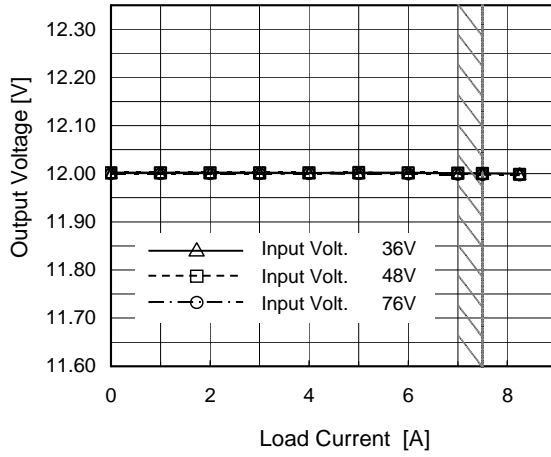
(e) Dynamic Load Response  
Load 50%(8A)→Load 100%(16A)/50us  
Vin 48V, Vout 5.0V



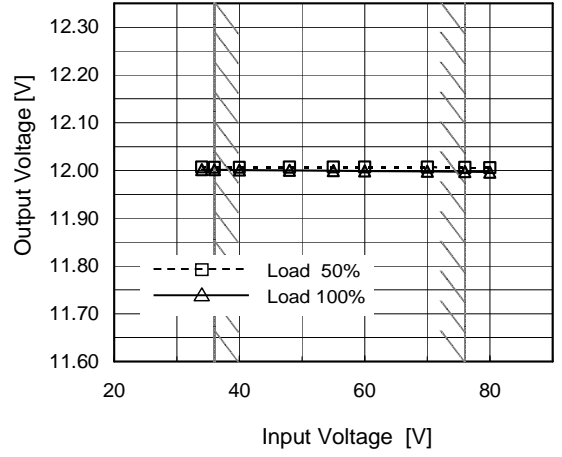
(f) Dynamic Load Response  
Load 100%(16A)→Load 50%(8A)/50us  
Vin 48V, Vout 5.0V

### 5.2.3 CHS804812

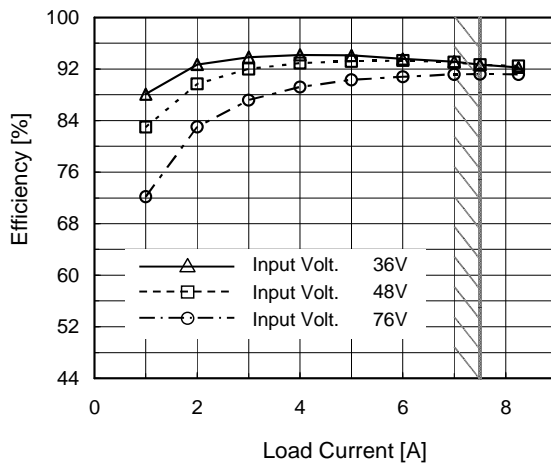
Fig.5.2.3  
Overview of  
CHS804812 at 25°C



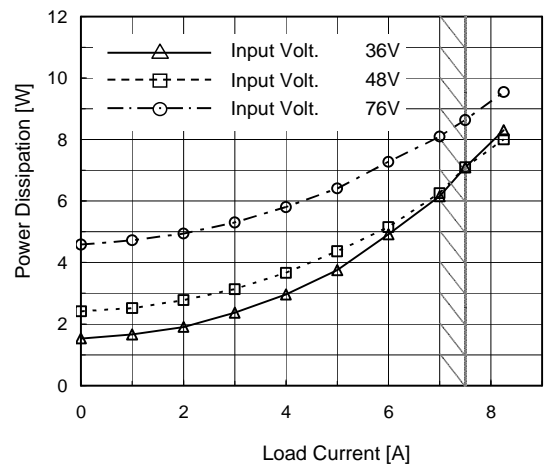
(a) Load Regulation



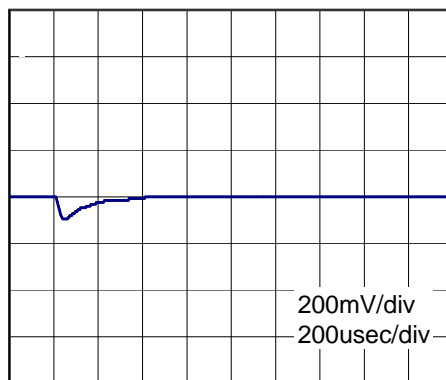
(b) Line Regulation



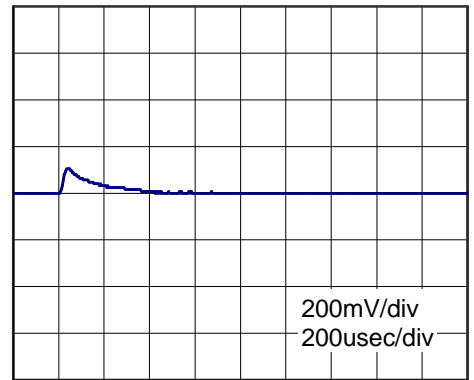
(c) Efficiency (by Load Current)



(d) Power Dissipation (by Load Current)



(e) Dynamic Load Response  
Load 50%(3.75A)→Load 100%(7.5A)/50us  
Vin 48V, Vout 12V

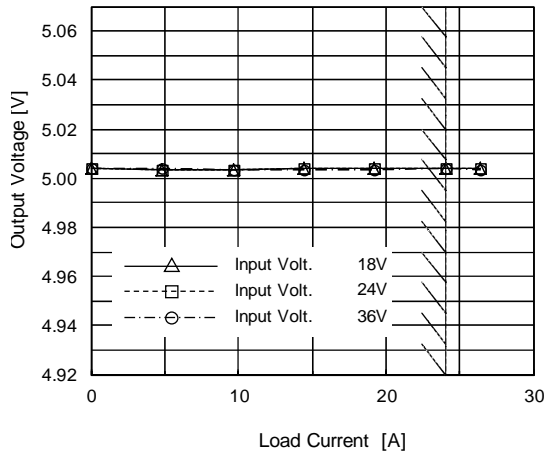


(f) Dynamic Load Response  
Load 100%(7.5A)→Load 50%(3.75A)/50us  
Vin 48V, Vout 12V

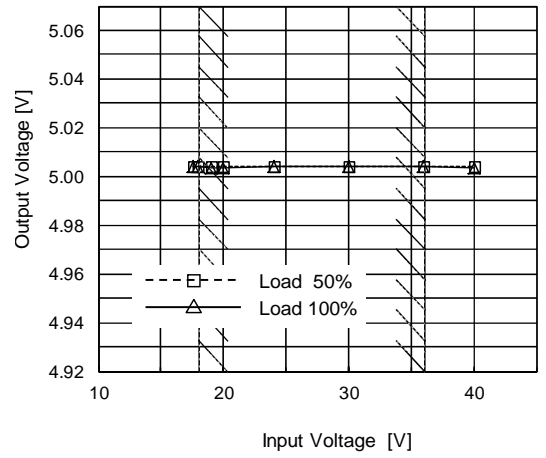
## 5.3 CHS120

### 5.3.1 CHS1202405

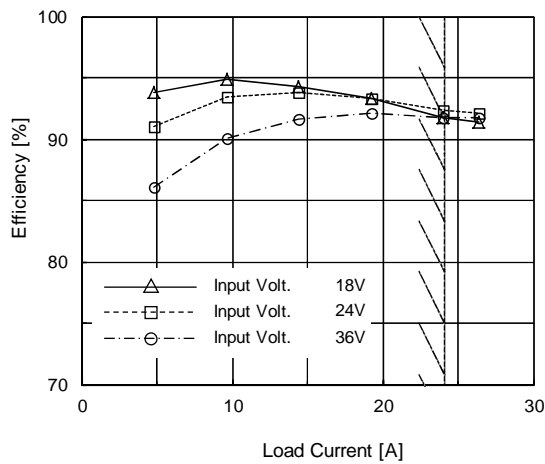
Fig.5.3.1  
Overview of  
CHS1202405 at 25°C



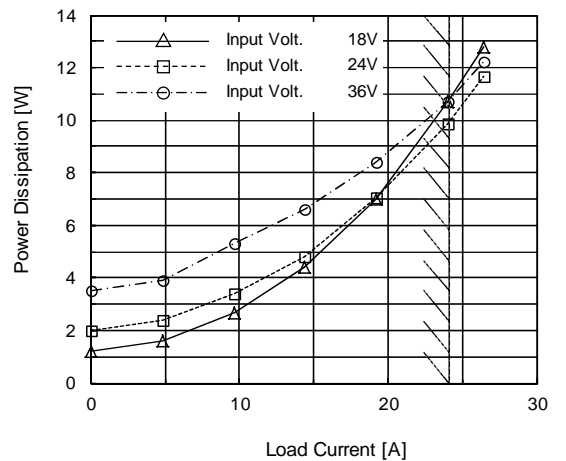
(a) Load Regulation



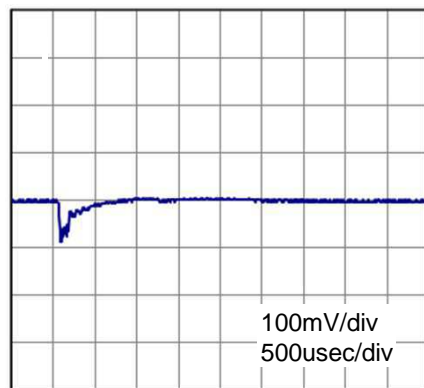
(b) Line Regulation



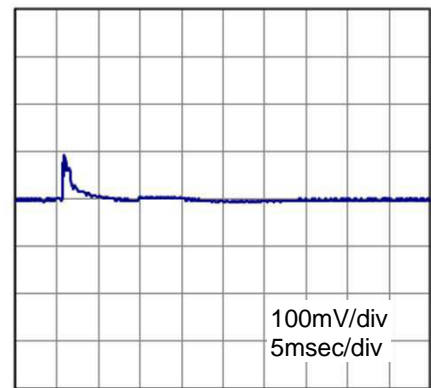
(c) Efficiency ( by Load Current )



(d) Power Dissipation( by Load Current )



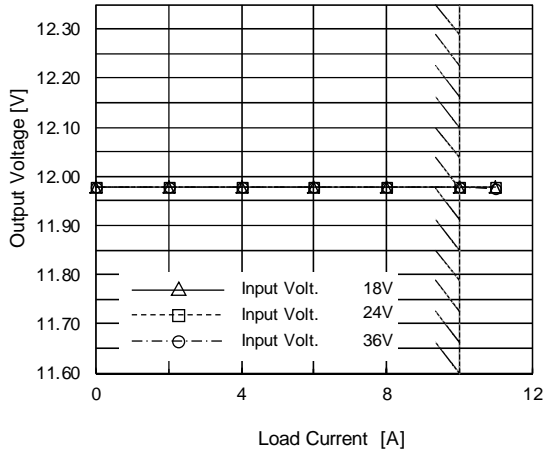
(e) Dynamic Load Response  
Load 50%(12A)→Load 100%(24A)∕50us  
Vin 24V, Vout 5.0V



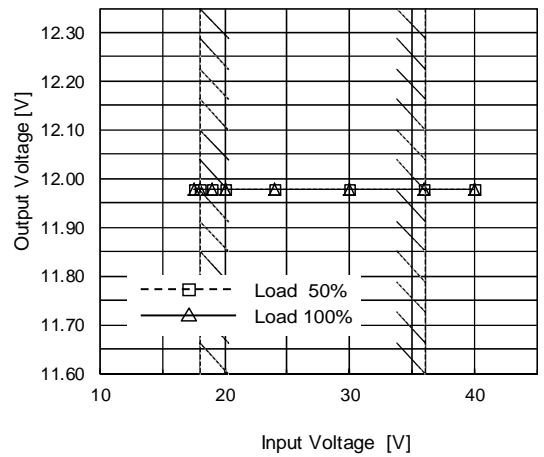
(f) Dynamic Load Response  
Load 100%(24A)→Load 50%(12A)∕50us  
Vin 24V, Vout 5.0V

### 5.3.2 CHS1202412

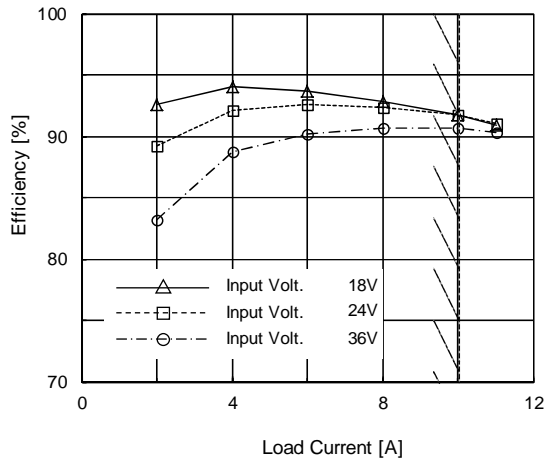
Fig.5.3.2  
Overview of  
CHS1202412 at 25°C



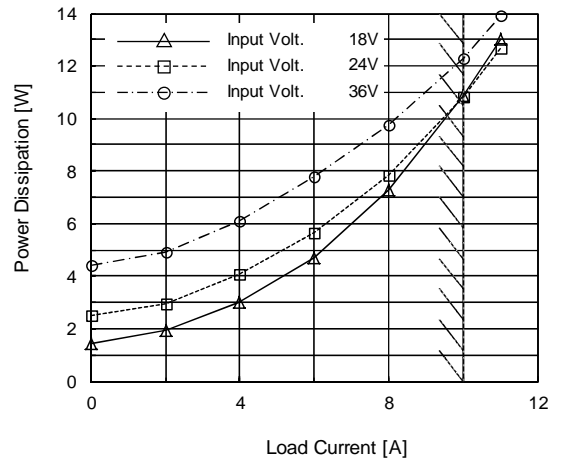
(a) Load Regulation



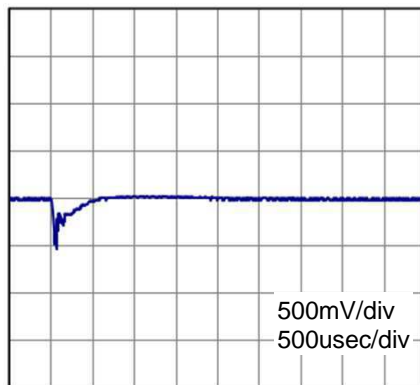
(b) Line Regulation



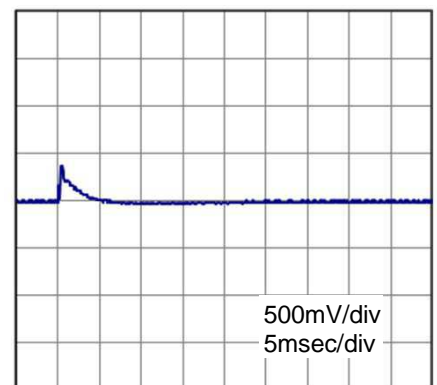
(c) Efficiency (by Load Current)



(d) Power Dissipation (by Load Current)



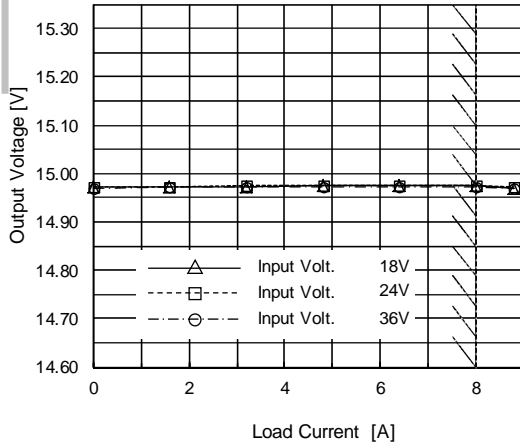
(e) Dynamic Load Response  
Load 50%(5A)→Load 100%(10A)/50us  
Vin 24V, Vout 12V



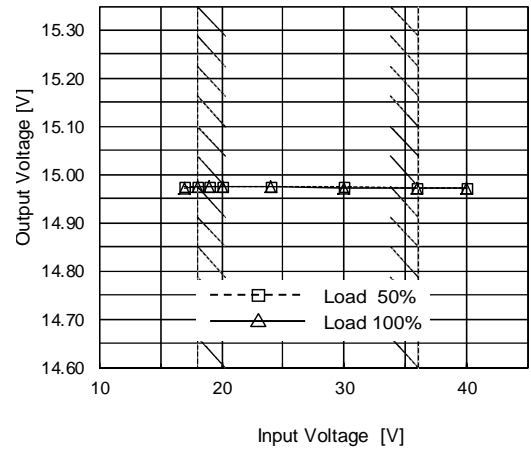
(f) Dynamic Load Response  
Load 100%(10A)→Load 50%(5A)/50us  
Vin 24V, Vout 12V

### 5.3.3 CHS1202415

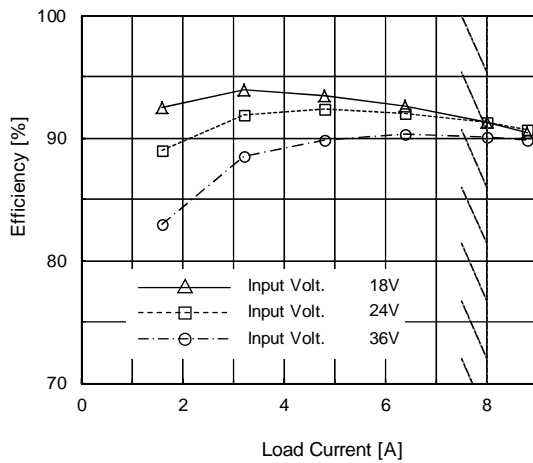
Fig.5.3.3  
Overview of  
CHS1202415 at 25°C



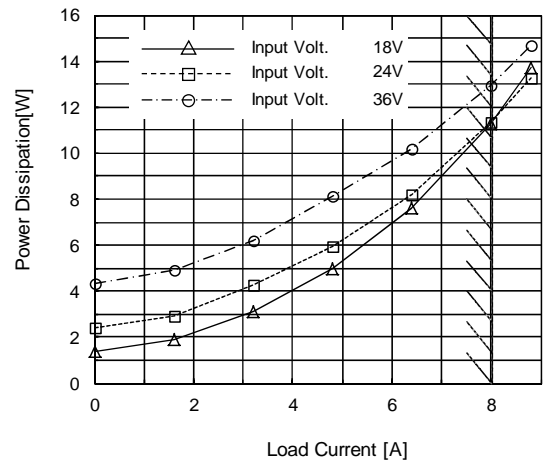
(a) Load Regulation



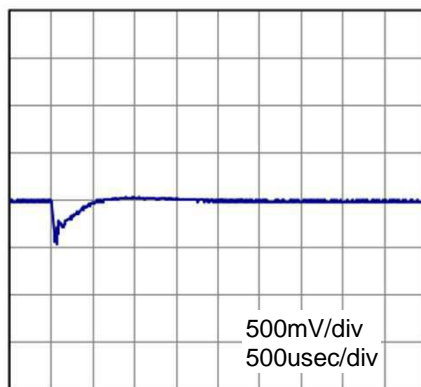
(b) Line Regulation



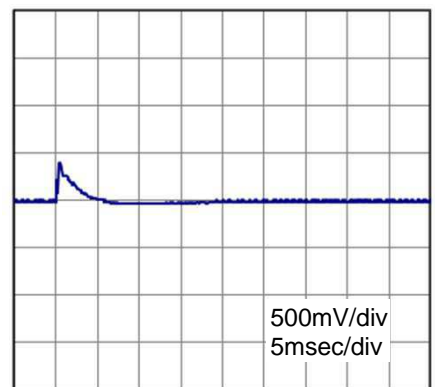
(c) Efficiency (by Load Current)



(d) Power Dissipation (by Load Current)



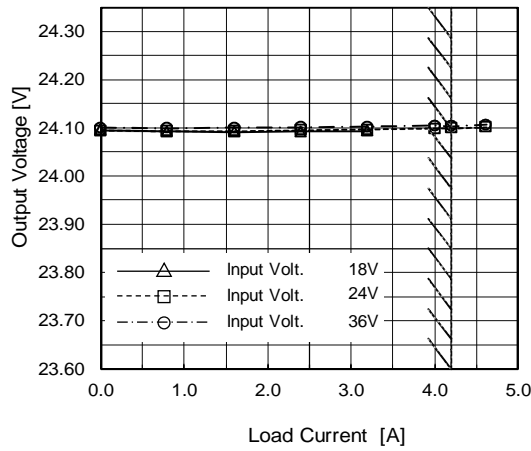
(e) Dynamic Load Response  
Load 50%(4A)→Load 100%(8A) / 50us  
Vin 24V, Vout 15V



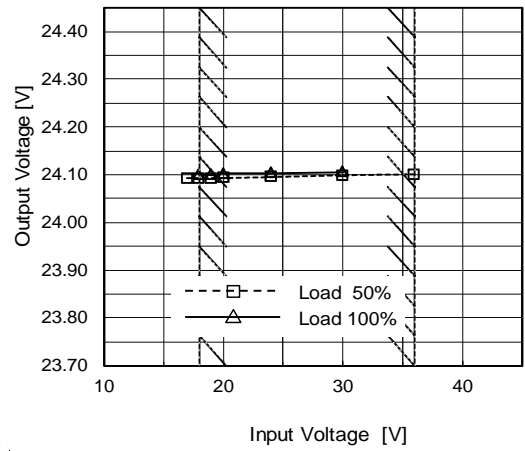
(f) Dynamic Load Response  
Load 100%(8A)→Load 50%(4A) / 50us  
Vin 24V, Vout 15V

### 5.3.4 CHS1202424

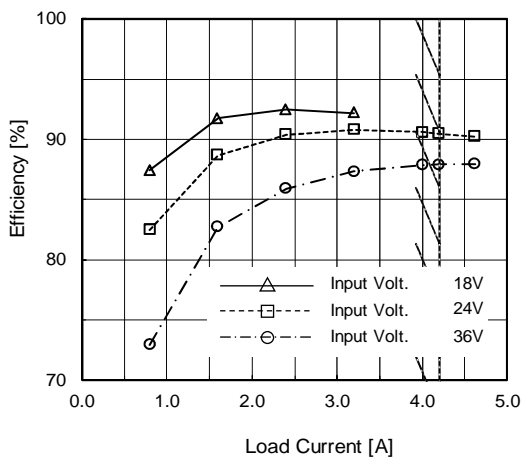
Fig.5.3.4  
Overview of  
CHS1202424 at 25°C



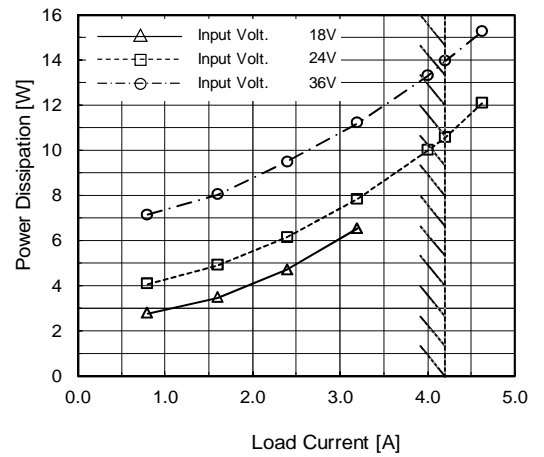
(a) Load Regulation



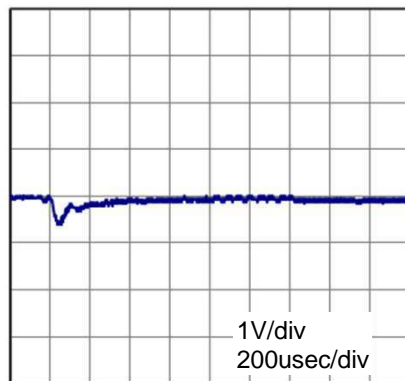
(b) Line Regulation



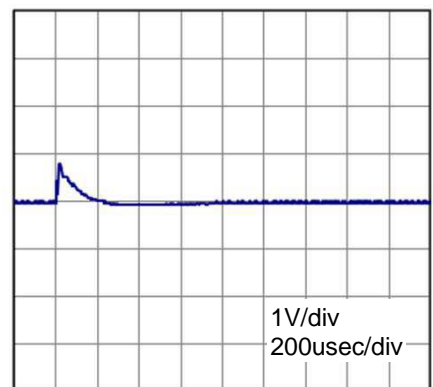
(c) Efficiency (by Load Current)



(d) Power Dissipation (by Load Current)



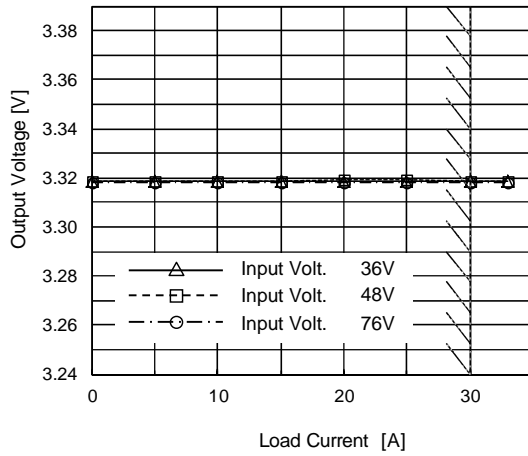
(e) Dynamic Load Response  
Load 50%(2.1A)→Load 100%(4.2A) / 50us  
Vin 24V, Vout 24V



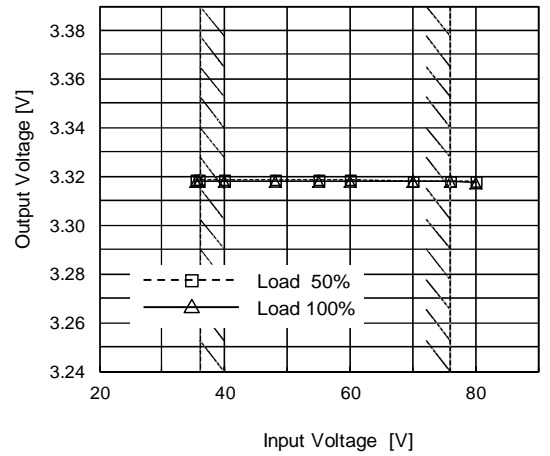
(f) Dynamic Load Response  
Load 100%(4.2A)→Load 50%(2.1A) / 50us  
Vin 24V, Vout 24V

### 5.3.5 CHS120483R3

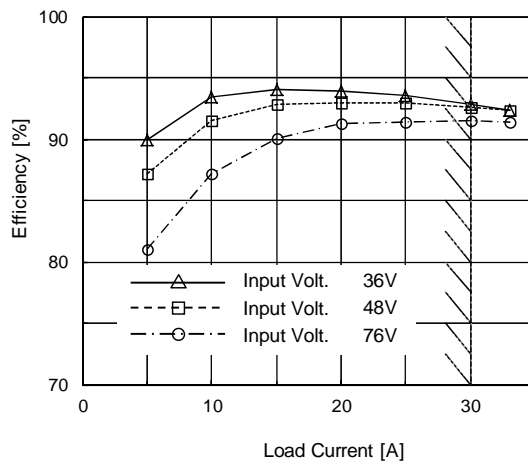
Fig.5.3.5  
Overview of  
CHS120483R3 at 25°C



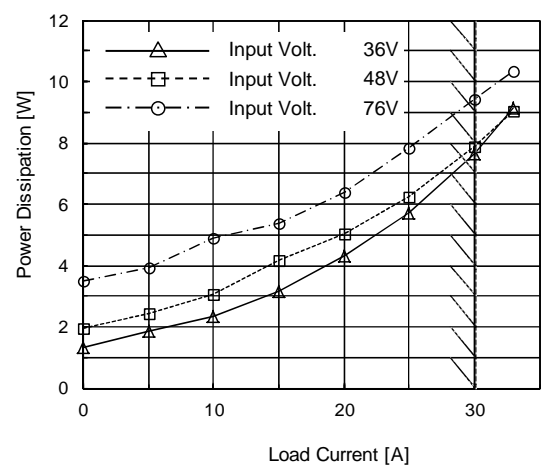
(a) Load Regulation



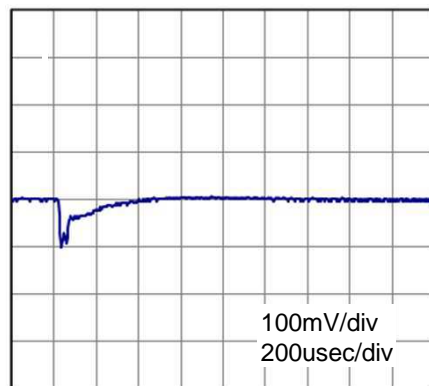
(b) Line Regulation



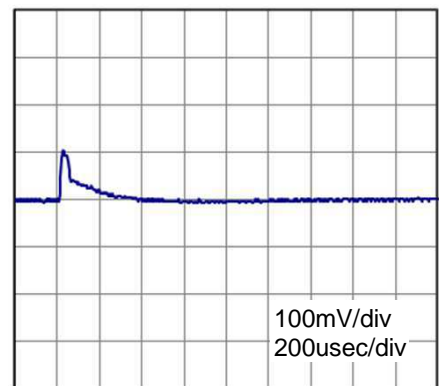
(c) Efficiency (by Load Current)



(d) Power Dissipation (by Load Current)



(e) Dynamic Load Response  
Load 50%(15A)→Load 100%(30A) / 50us  
Vin 48V, Vout 3.3V

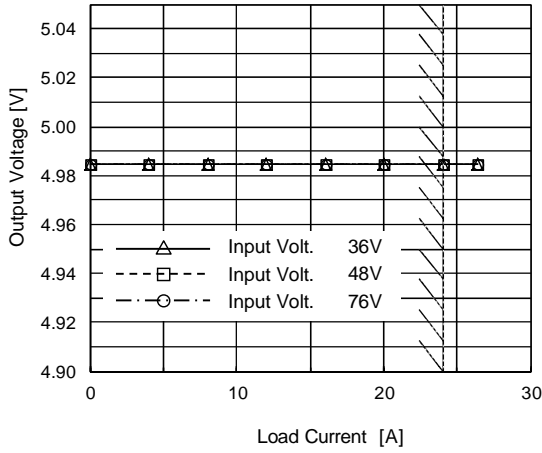


(f) Dynamic Load Response  
Load 100%(30A)→Load 50%(15A) / 50us  
Vin 48V, Vout 3.3V

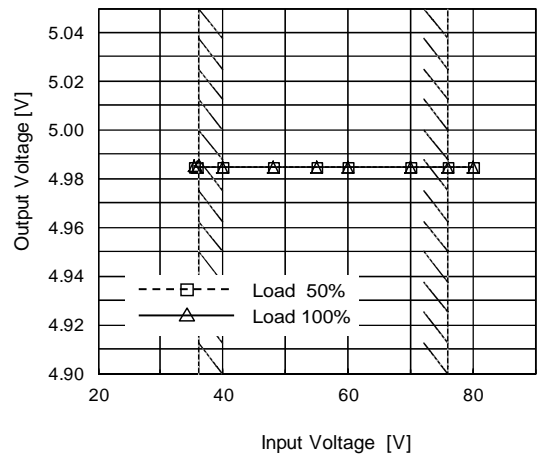


### 5.3.6 CHS1204805

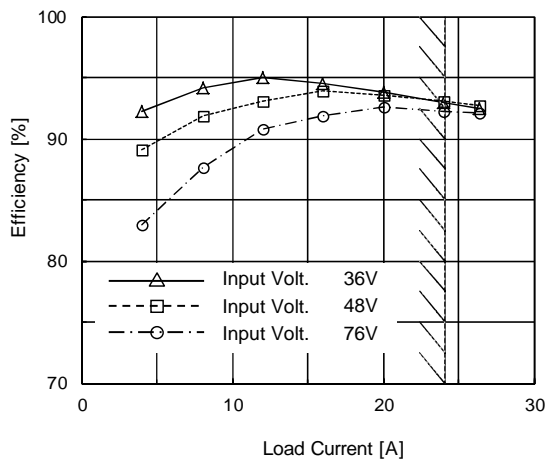
Fig.5.3.6  
Overview of  
CHS1204805 at 25°C



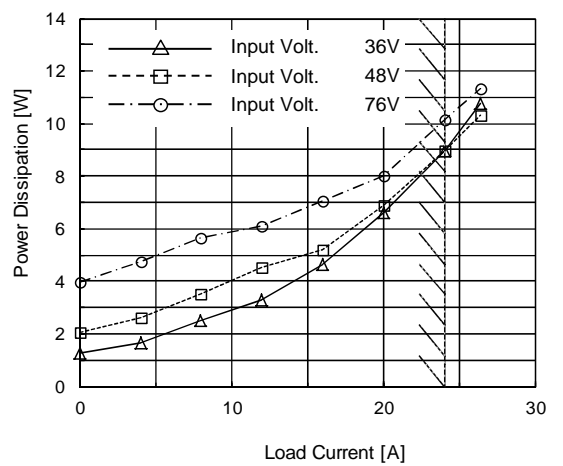
(a) Load Regulation



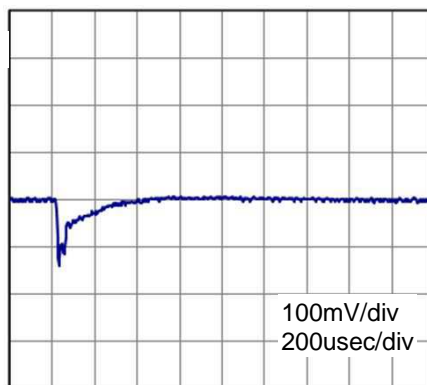
(b) Line Regulation



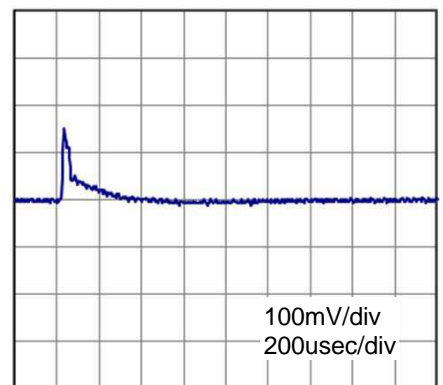
(c) Efficiency (by Load Current)



(d) Power Dissipation (by Load Current)



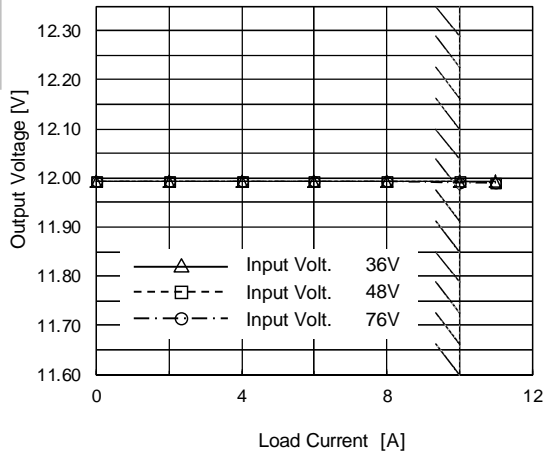
(e) Dynamic Load Response  
Load 50%(12A)→Load 100%(24A)/50us  
Vin 48V, Vout 5.0V



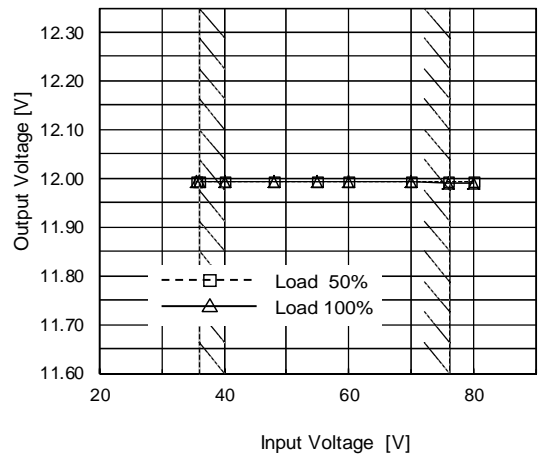
(f) Dynamic Load Response  
Load 100%(24A)→Load 50%(12A)/50us  
Vin 48V, Vout 5.0V

### 5.3.7 CHS1204812

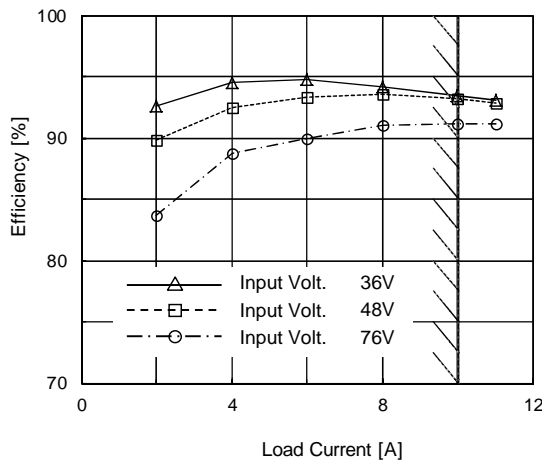
Fig.5.3.7  
Overview of  
CHS1204812 at 25°C



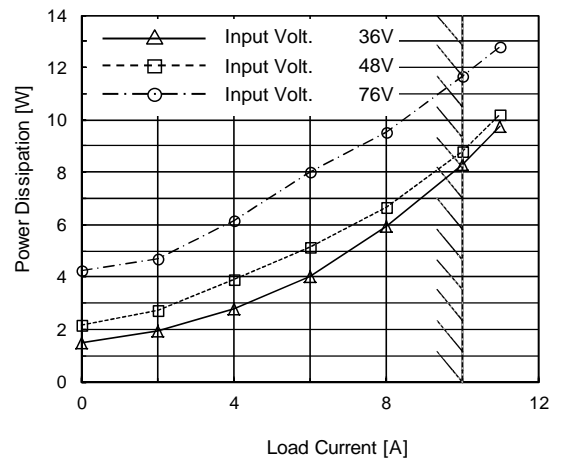
(a) Load Regulation



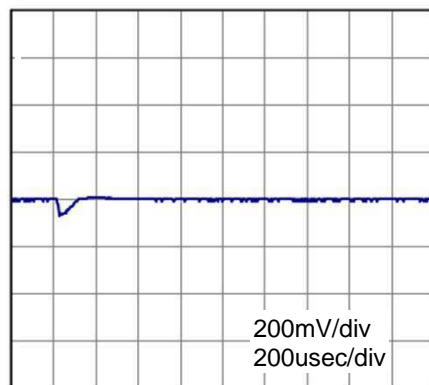
(b) Line Regulation



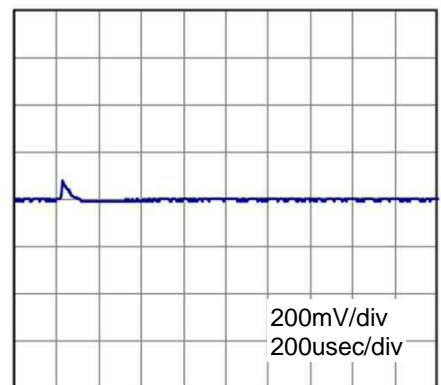
(c) Efficiency (by Load Current)



(d) Power Dissipation (by Load Current)



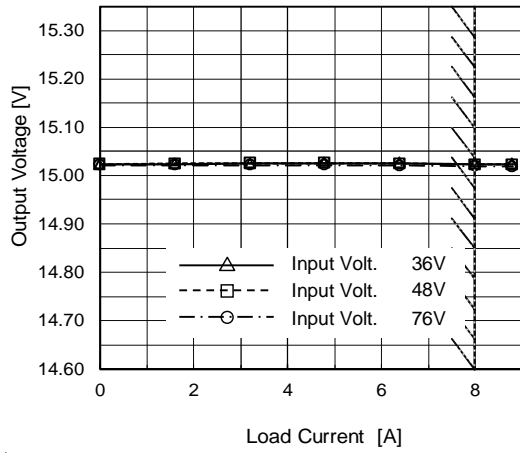
(e) Dynamic Load Response  
Load 50%(5A)→Load 100%(10A)/50us  
Vin 48V, Vout 12V



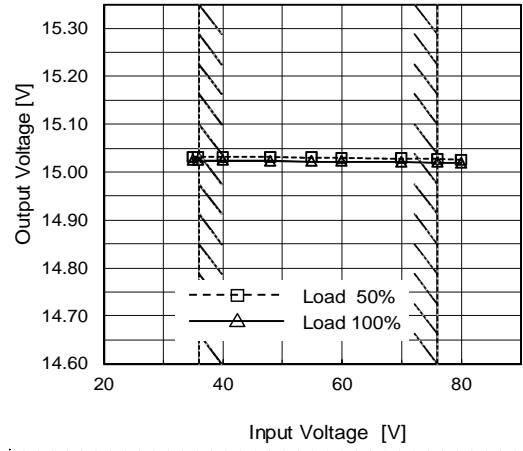
(f) Dynamic Load Response  
Load 100%(10A)→Load 50%(5A)/50us  
Vin 48V, Vout 12V

### 5.3.8 CHS1204815

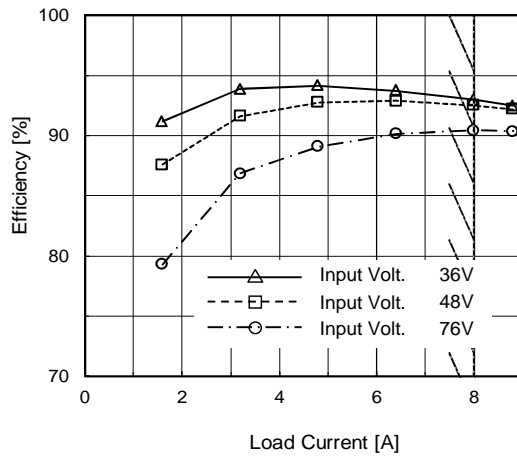
Fig.5.3.8  
Overview of  
CHS1204815 at 25°C



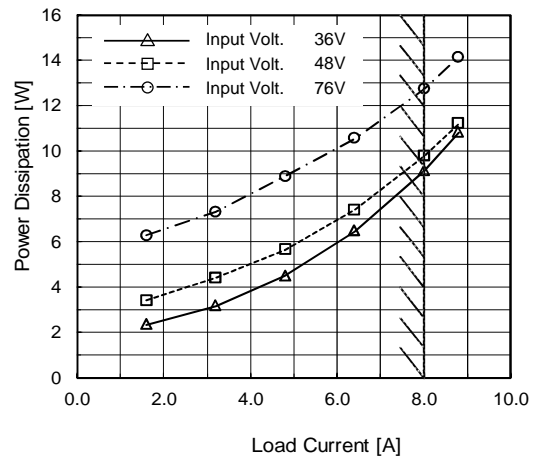
(a) Load Regulation



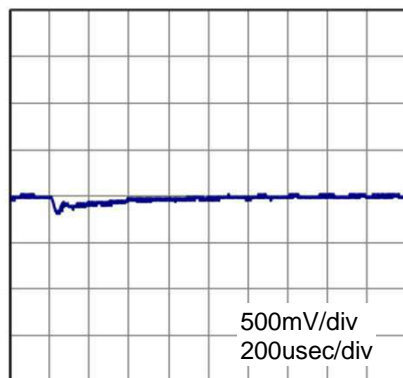
(b) Line Regulation



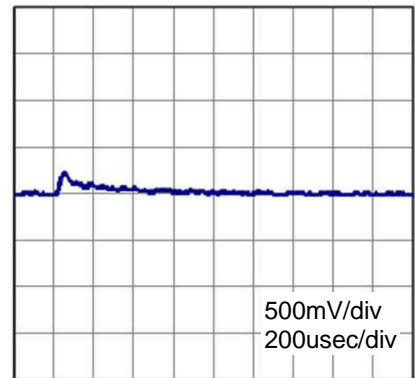
(c) Efficiency (by Load Current)



(d) Power Dissipation (by Load Current)



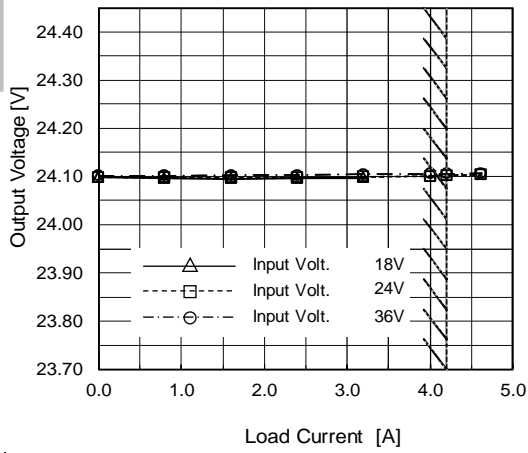
(e) Dynamic Load Response  
Load 50%(4A)→Load 100%(8A)/50us  
Vin 48V, Vout 15V



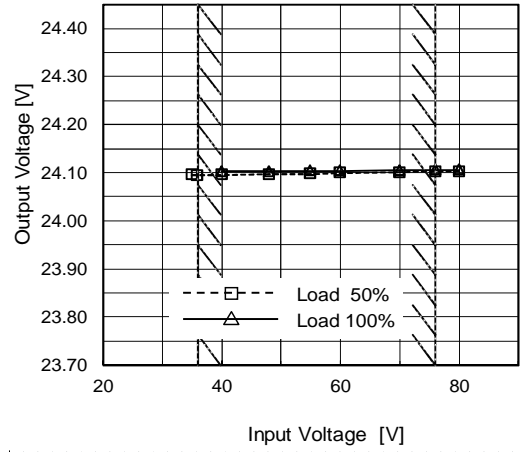
(f) Dynamic Load Response  
Load 100%(8A)→Load 50%(4A)/50us  
Vin 48V, Vout 15V

### 5.3.9 CHS1204824

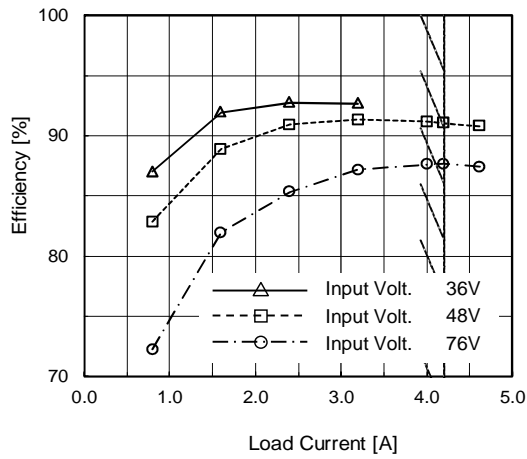
Fig.5.3.9  
Overview of  
CHS1204824 at 25°C



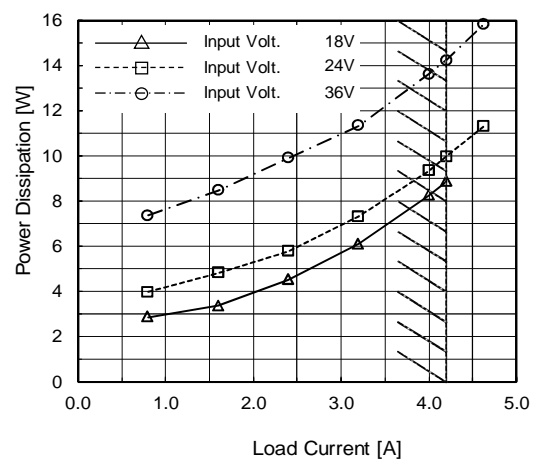
(a) Load Regulation



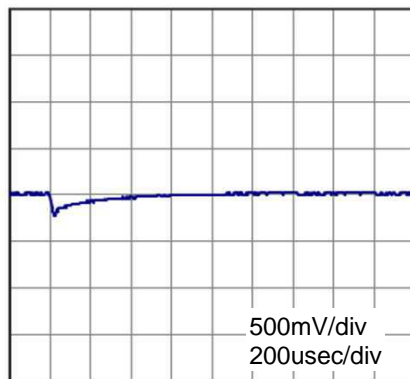
(b) Line Regulation



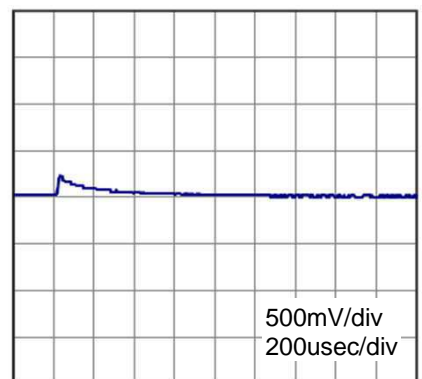
(c) Efficiency (by Load Current)



(d) Power Dissipation (by Load Current)



(e) Dynamic Load Response  
Load 50%(2.1A)→Load 100%(4.2A) / 50µs  
Vin 48V, Vout 24V

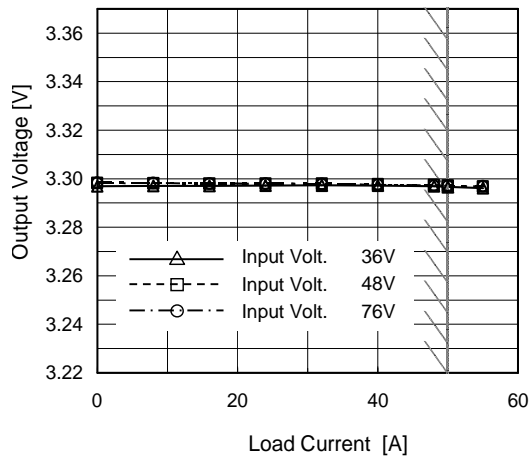


(f) Dynamic Load Response  
Load 100%(4.2A)→Load 50%(2.1A) / 50µs  
Vin 48V, Vout 24V

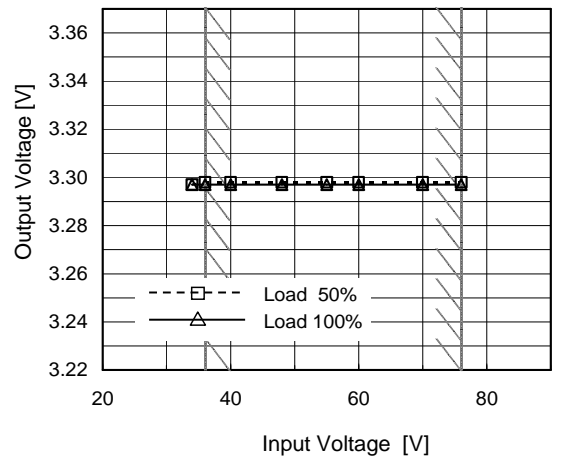
## 5.4 CHS200

### 5.4.1 CHS200483R3

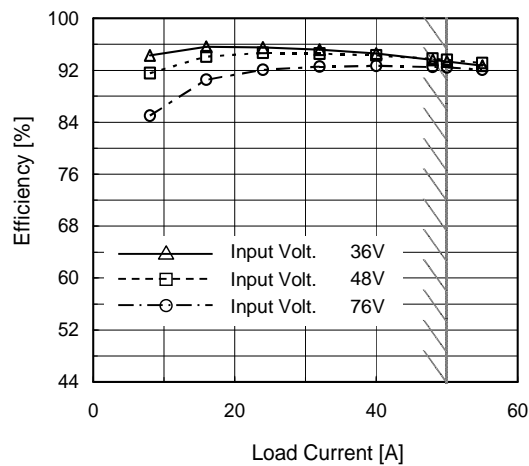
Fig.5.4.1  
Overview of  
CHS200483R3 at 25°C



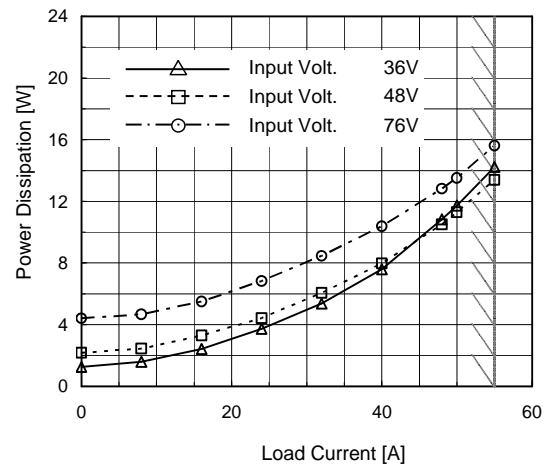
(a) Load Regulation



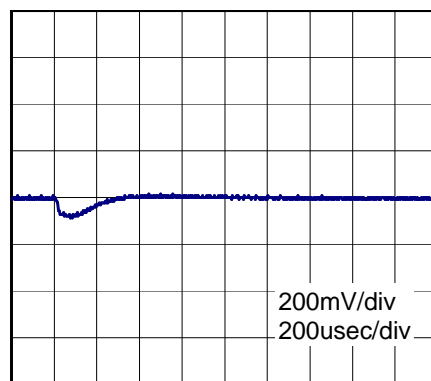
(b) Line Regulation



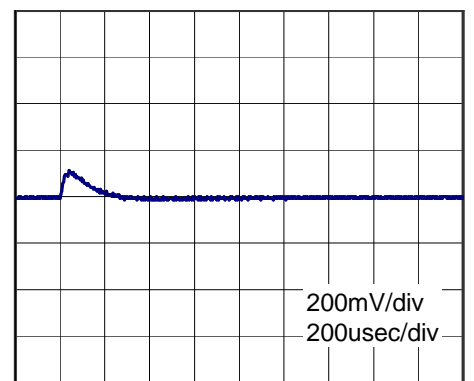
(c) Efficiency ( by Load Current )



(d) Power Dissipation( by Load Current )



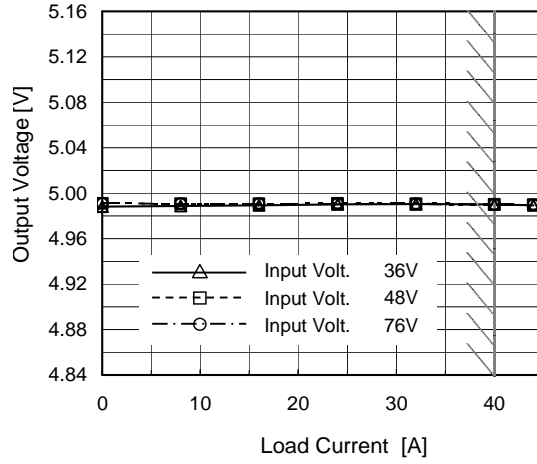
(e) Dynamic Load Response  
Load 50%(25A)→Load 100%(50A) / 50us  
Vin 48V, Vout 3.3V



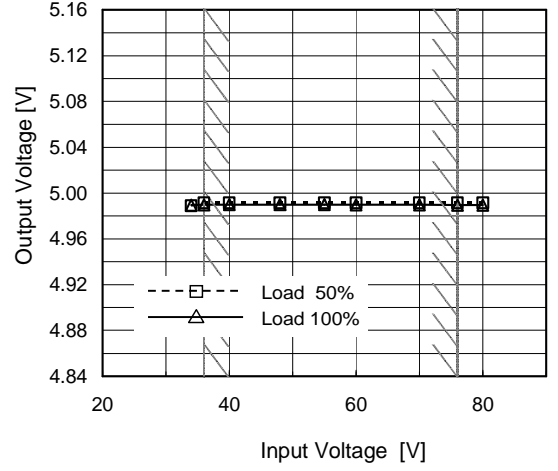
(f) Dynamic Load Response  
Load 100%(50A)→Load 50%(25A) / 50us  
Vin 48V, Vout 3.3V

## 5.4.2 CHS2004805

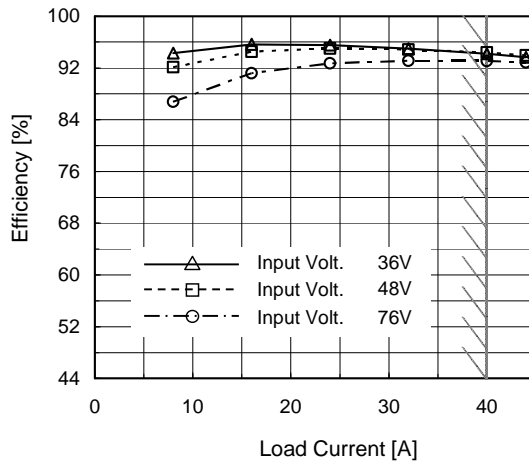
Fig.5.4.2  
Overview of  
CHS2004805 at 25°C



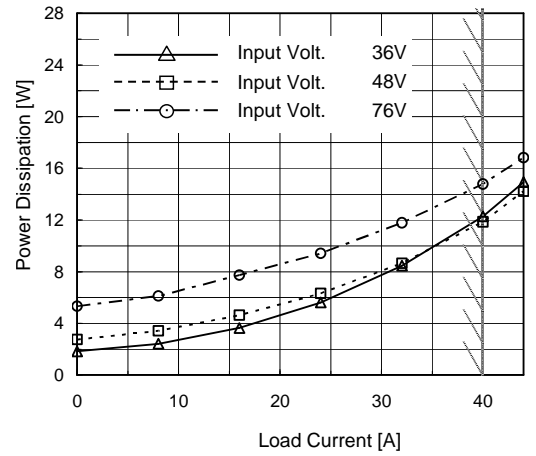
(a) Load Regulation



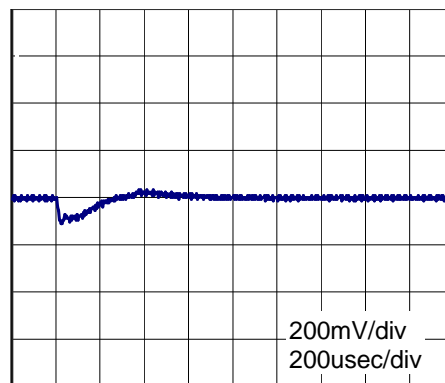
(b) Line Regulation



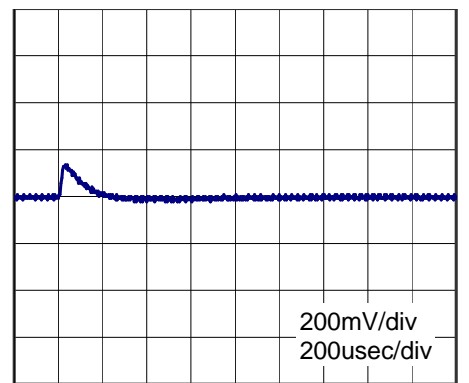
(c) Efficiency (by Load Current)



(d) Power Dissipation (by Load Current)



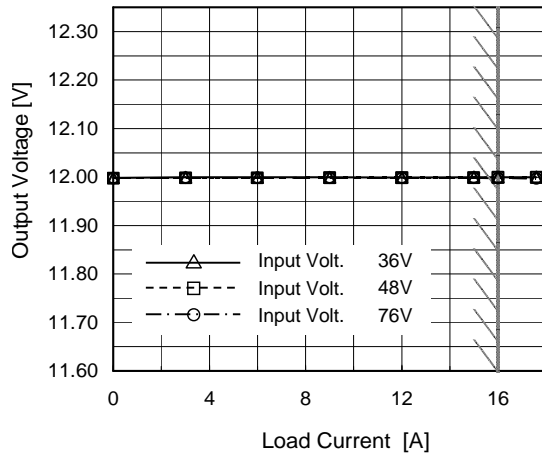
(e) Dynamic Load Response  
Load 50%(20A)→Load 100%(40A)/50us  
Vin 48V, Vout 5V



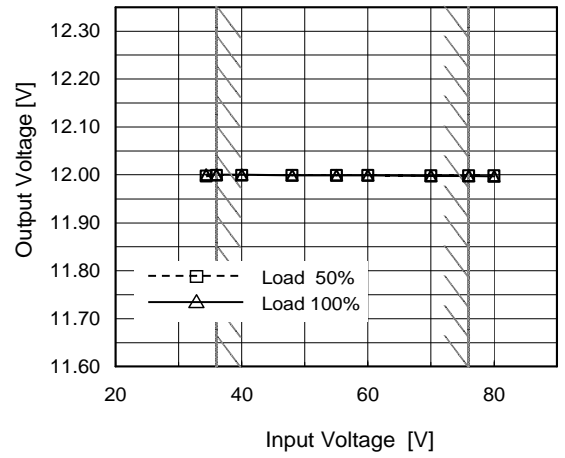
(f) Dynamic Load Response  
Load 100%(40A)→Load 50%(20A)/50us  
Vin 48V, Vout 5V

### 5.4.3 CHS2004812

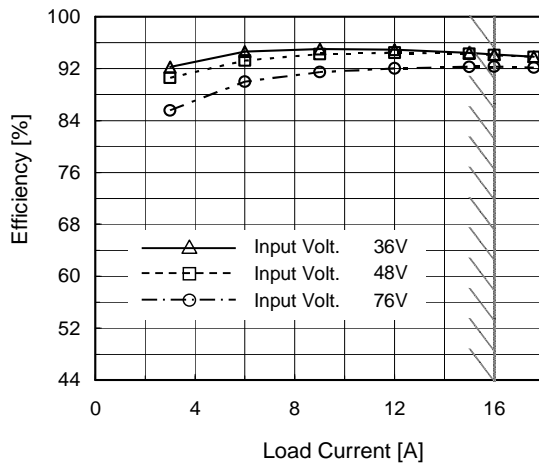
Fig.5.4.3  
Overview of  
CHS2004812 at 25°C



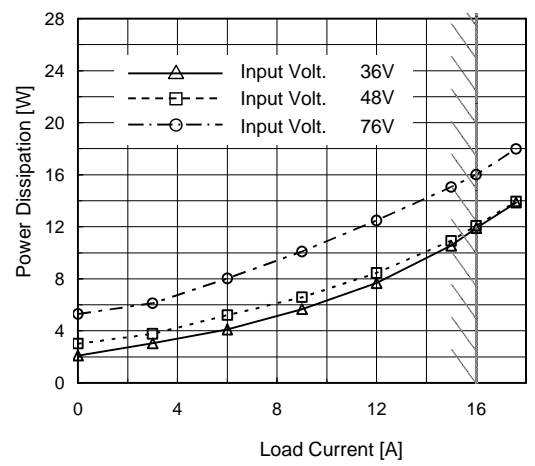
(a) Load Regulation



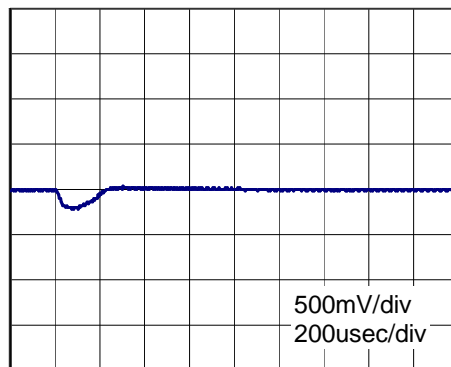
(b) Line Regulation



(c) Efficiency (by Load Current)

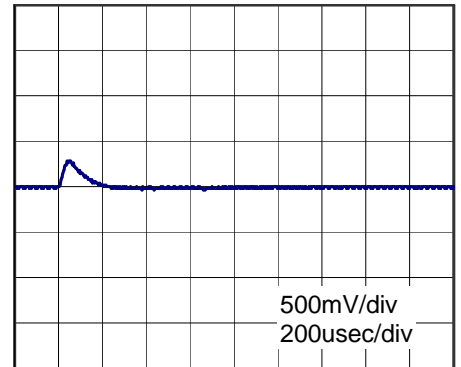


(d) Power Dissipation (by Load Current)



(e) Dynamic Load Response

Load 50%(8A)→Load 100%(16A) / 50us  
Vin 48V, Vout 12V

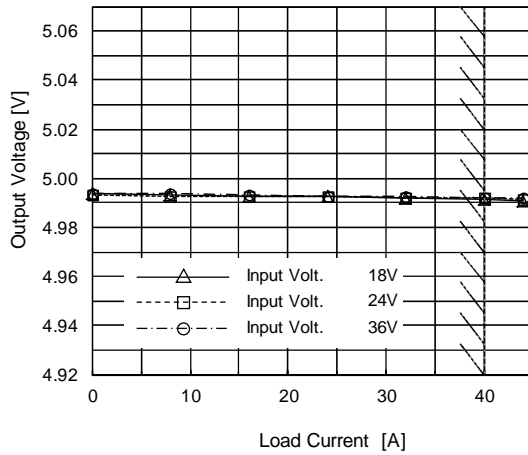


(f) Dynamic Load Response

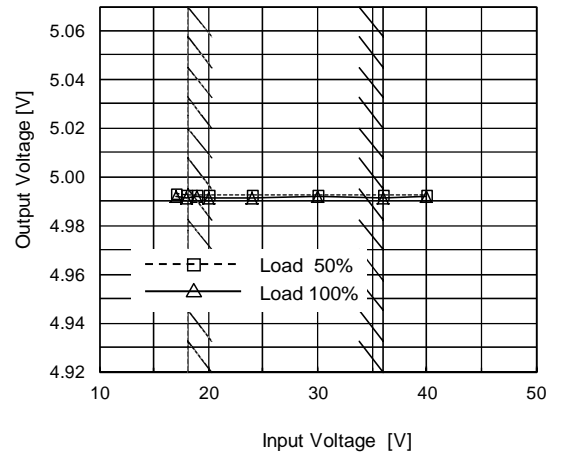
Load 100%(16A)→Load 50%(8A) / 50us  
Vin 48V, Vout 12V

5.5.1 CHS3002405

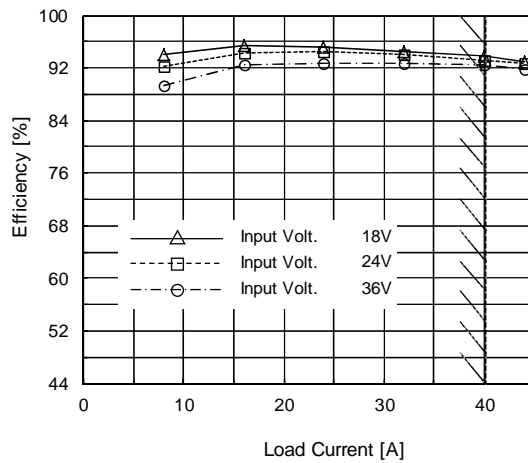
Fig.5.5.1  
Overview of  
CHS3002405 at 25°C



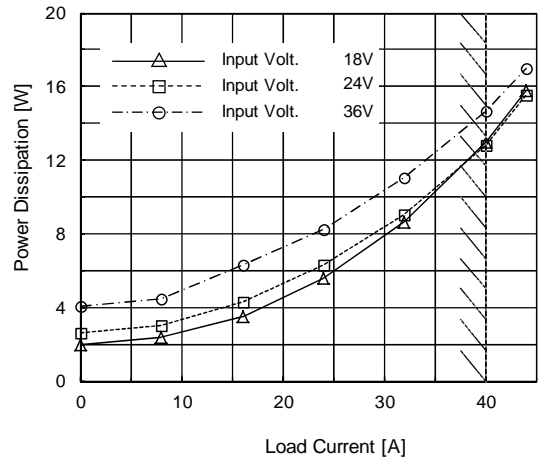
(a) Load Regulation



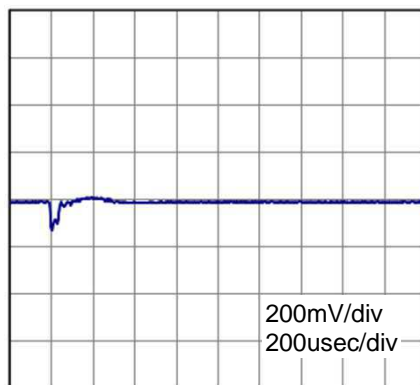
(b) Line Regulation



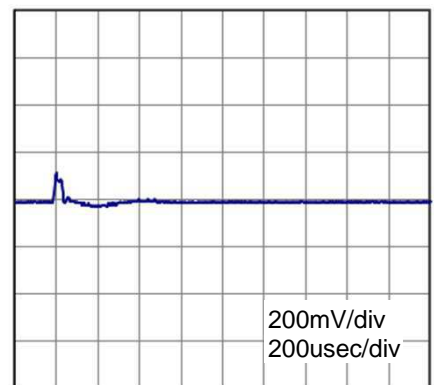
(c) Efficiency ( by Load Current )



(d) Power Dissipation( by Load Current )



(e) Dynamic Load Response  
Load 50%(20A)→Load 100%(40A) / 50us  
Vin 24V, Vout 5V

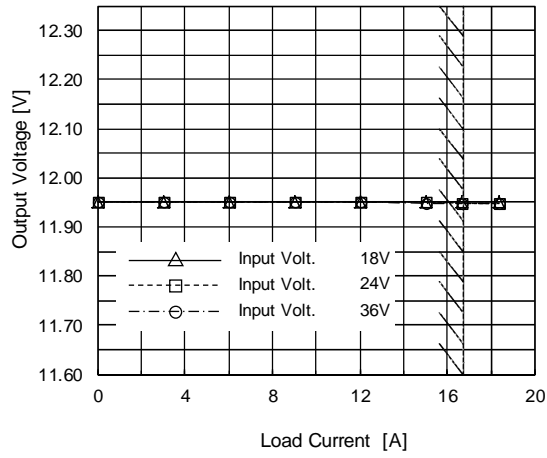


(f) Dynamic Load Response  
Load 100%(40A)→Load 50%(20A) / 50us  
Vin 24V, Vout 5V

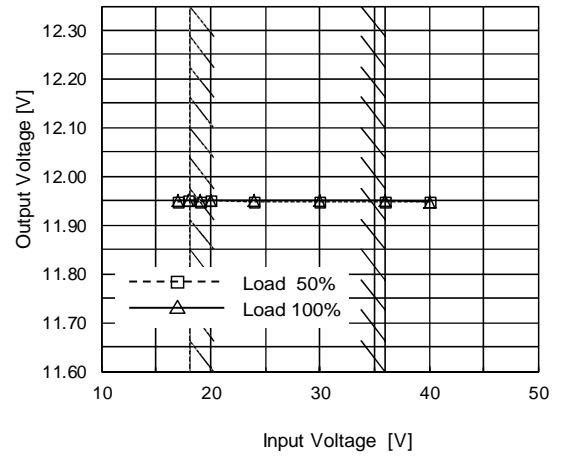


## 5.5.2 CHS3002412

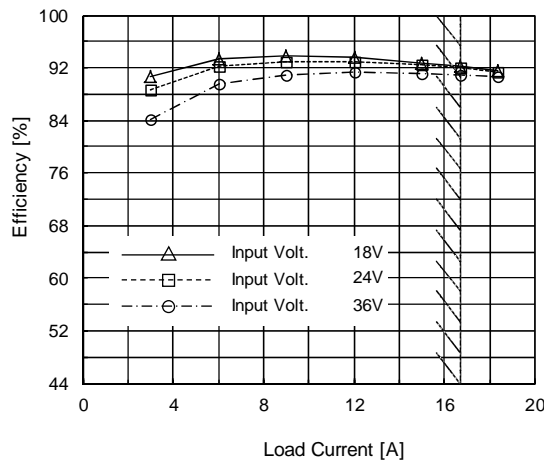
Fig.5.5.2  
Overview of  
CHS3002412 at 25°C



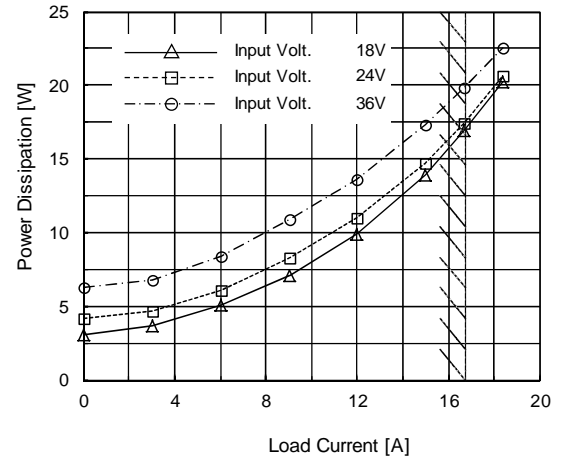
(a) Load Regulation



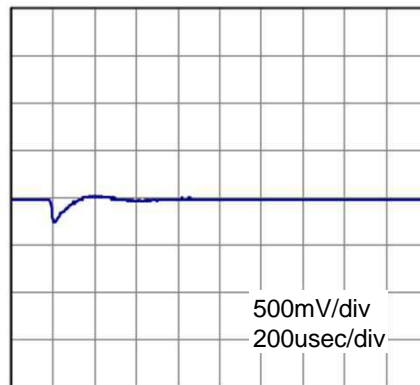
(b) Line Regulation



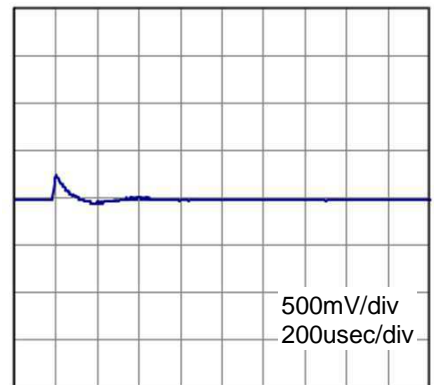
(c) Efficiency (by Load Current)



(d) Power Dissipation (by Load Current)



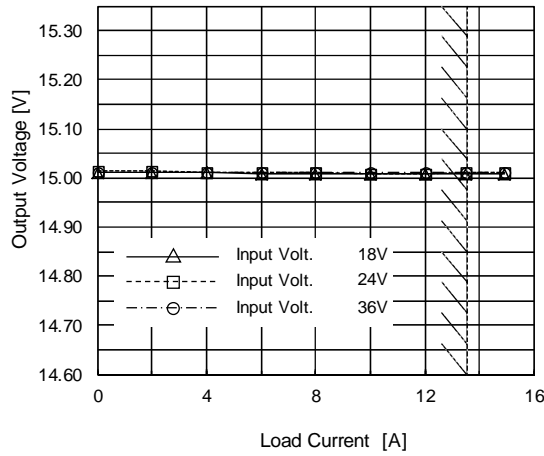
(e) Dynamic Load Response  
Load 50%(8.35A)→Load 100%(16.7A) / 50us  
Vin 24V, Vout 12V



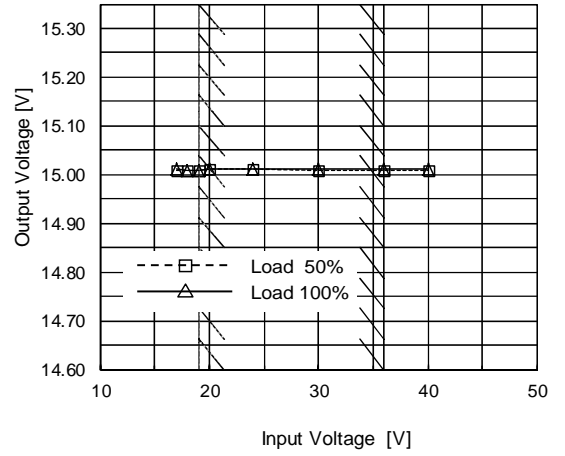
(f) Dynamic Load Response  
Load 100%(16.7A)→Load 50%(8.35A) / 50us  
Vin 24V, Vout 12V

### 5.5.3 CHS3002415

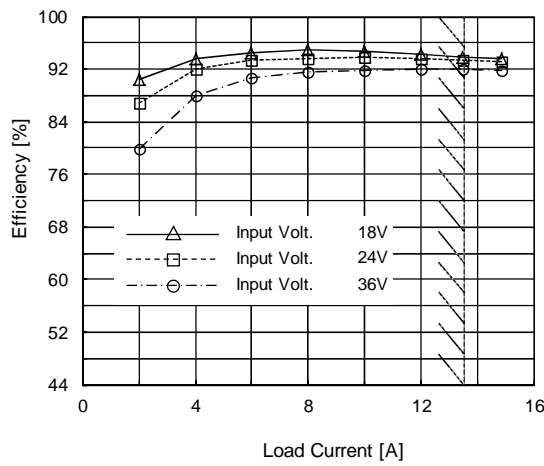
Fig.5.5.3  
Overview of  
CHS3002415 at 25°C



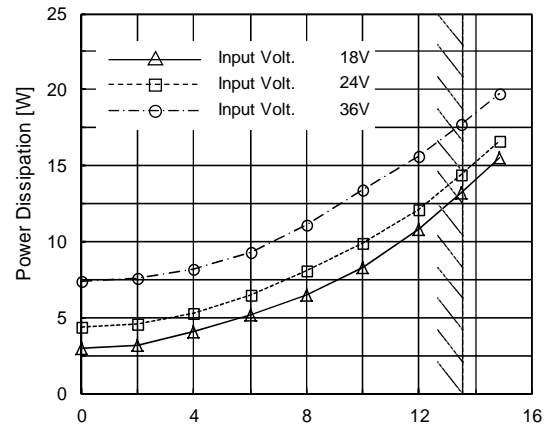
(a) Load Regulation



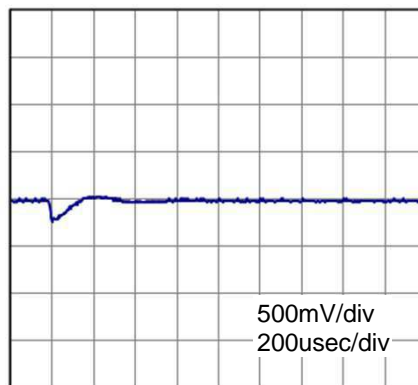
(b) Line Regulation



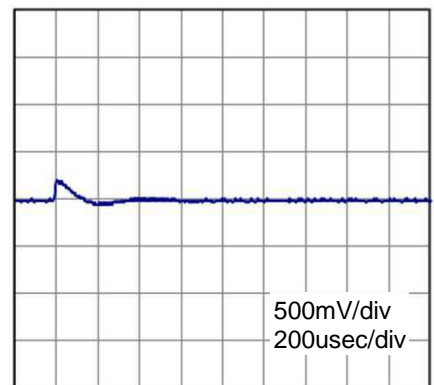
(c) Efficiency (by Load Current)



(d) Power Dissipation (by Load Current)



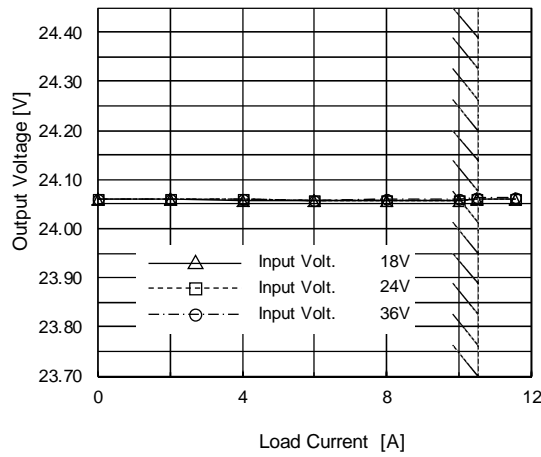
(e) Dynamic Load Response  
Load 50%(6.75A)→Load 100%(13.5A) / 50us  
Vin 24V, Vout 15V



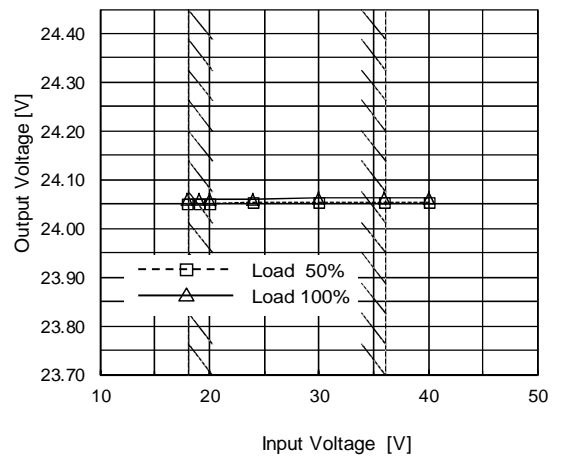
(f) Dynamic Load Response  
Load 100%(13.5A)→Load 50%(6.75A) / 50us  
Vin 24V, Vout 15V

## 5.5.4 CHS3002424

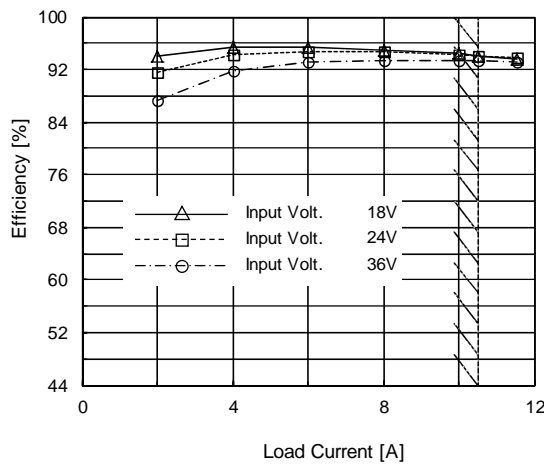
Fig.5.5.4  
Overview of  
CHS3002424 at 25°C



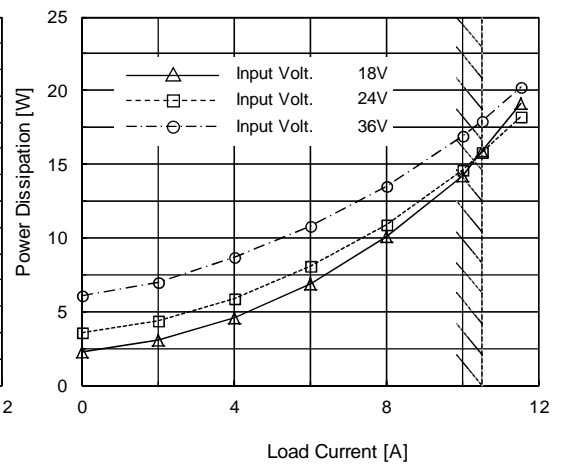
(a) Load Regulation



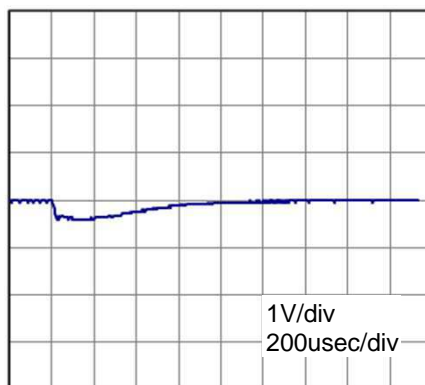
(b) Line Regulation



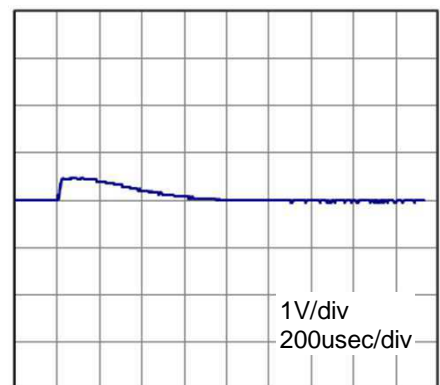
(c) Efficiency ( by Load Current )



(d) Power Dissipation( by Load Current )



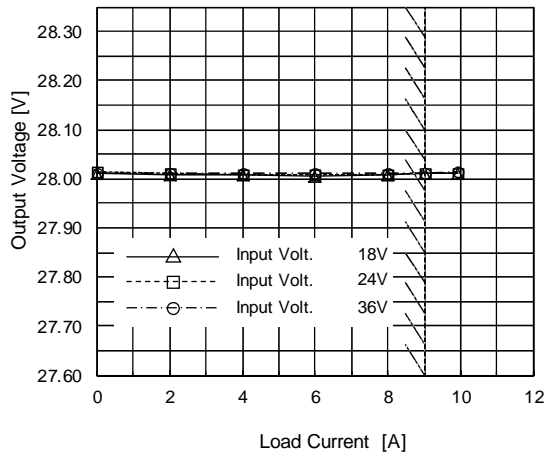
(e) Dynamic Load Response  
Load 50%(5.25A)→Load 100%(10.5A) / 50us  
Vin 24V, Vout 24V



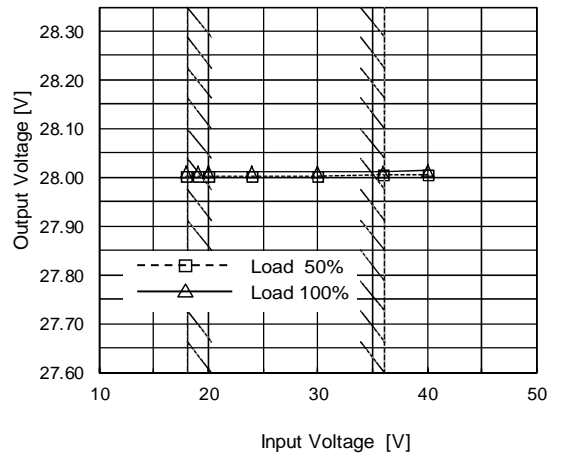
(f) Dynamic Load Response  
Load 100%(10.5A)→Load 50%(5.25A) / 50us  
Vin 24V, Vout 24V

### 5.5.5 CHS3002428

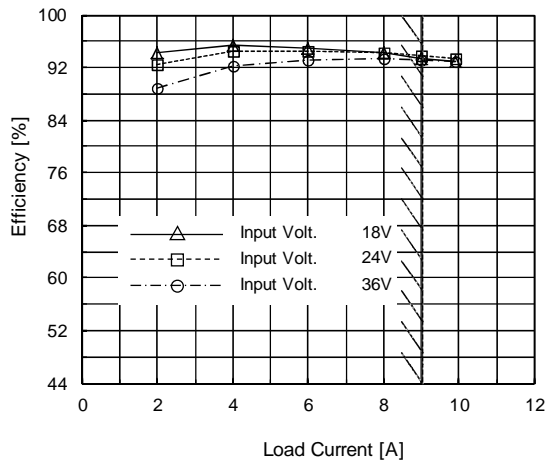
Fig.5.5.5  
Overview of  
CHS3002428 at 25°C



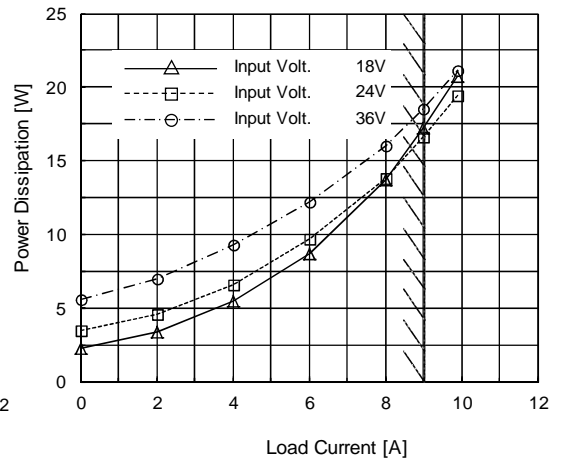
(a) Load Regulation



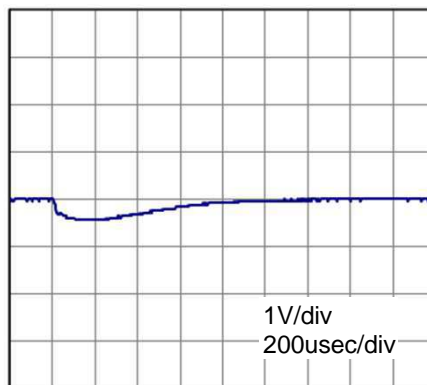
(b) Line Regulation



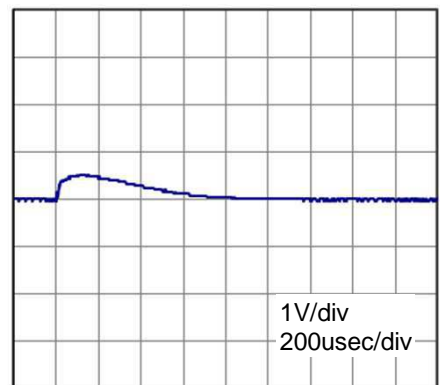
(c) Efficiency (by Load Current)



(d) Power Dissipation (by Load Current)



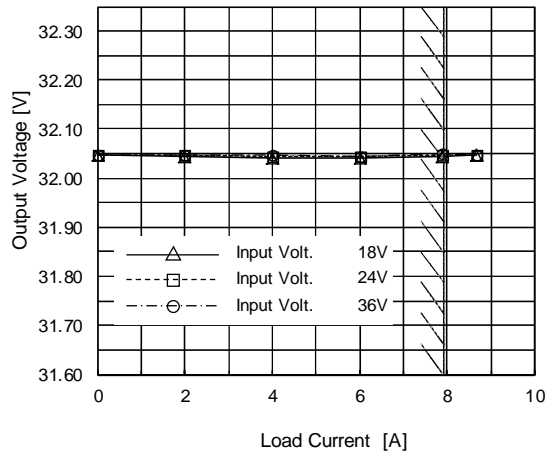
(e) Dynamic Load Response  
Load 50%(4.5A)→Load 100%(9A) / 50us  
Vin 24V, Vout 28V



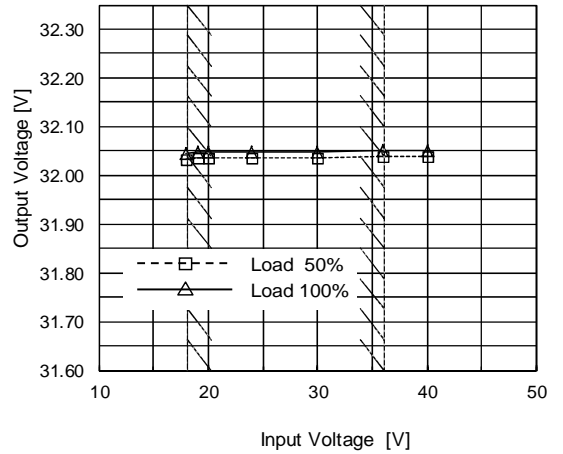
(f) Dynamic Load Response  
Load 100%(9A)→Load 50%(4.5A) / 50us  
Vin 24V, Vout 28V

## 5.5.6 CHS3002432

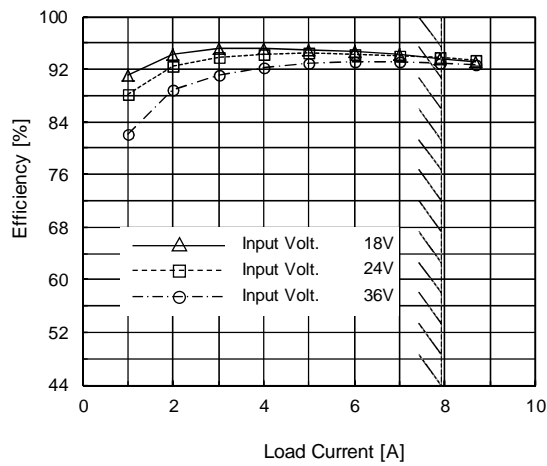
Fig.5.5.6  
Overview of  
CHS3002432 at 25°C



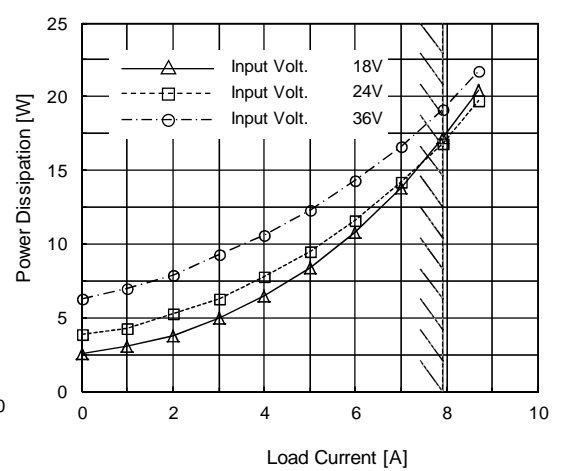
(a) Load Regulation



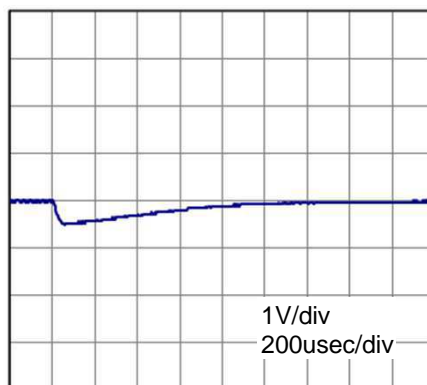
(b) Line Regulation



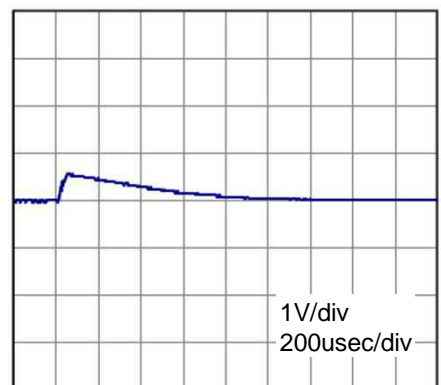
(c) Efficiency (by Load Current)



(d) Power Dissipation (by Load Current)



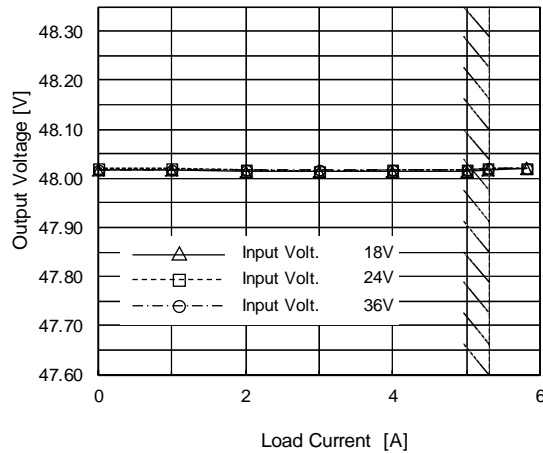
(e) Dynamic Load Response  
Load 50%(3.95A)→Load 100%(7.9A) / 50us  
Vin 24V, Vout 32V



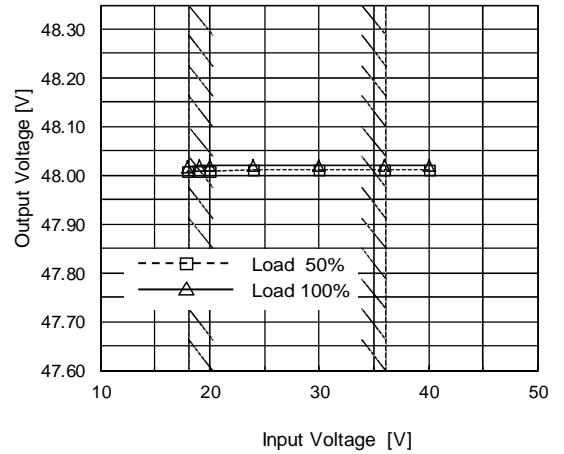
(f) Dynamic Load Response  
Load 100%(7.9A)→Load 50%(3.95A) / 50us  
Vin 24V, Vout 32V

## 5.5.7 CHS3002448

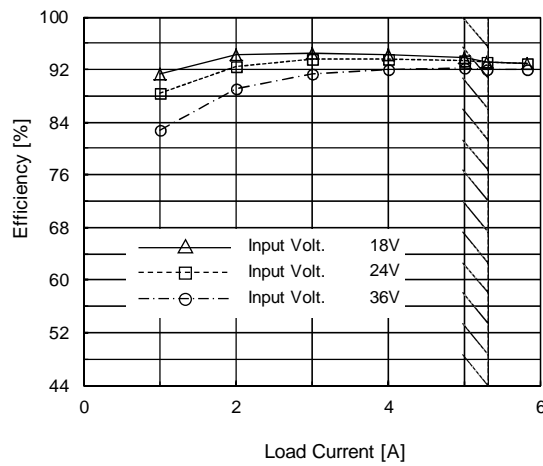
Fig.5.5.7  
Overview of  
CHS3002448 at 25°C



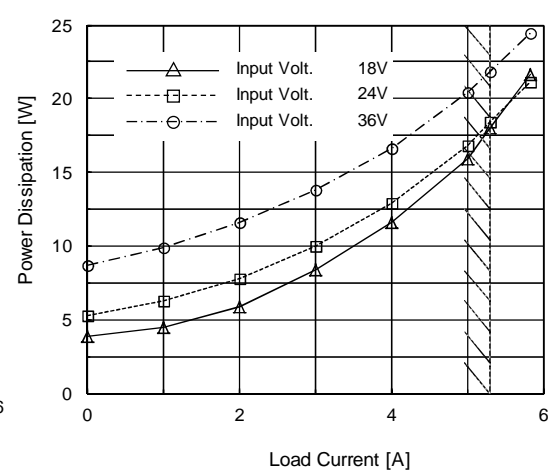
(a) Load Regulation



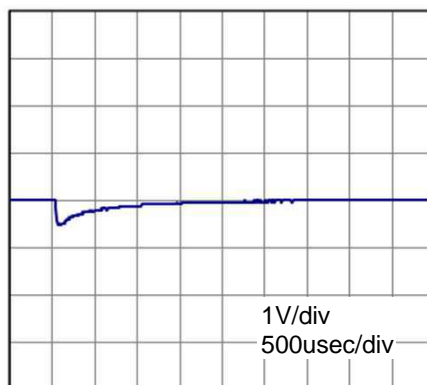
(b) Line Regulation



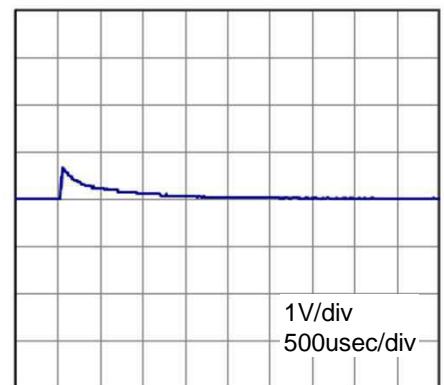
(c) Efficiency (by Load Current)



(d) Power Dissipation (by Load Current)



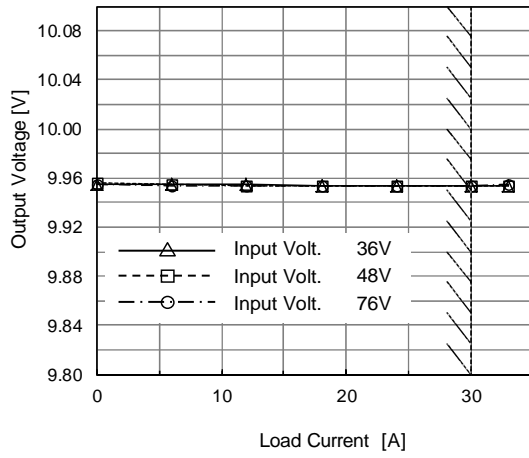
(e) Dynamic Load Response  
Load 50%(2.65A)→Load 100%(5.3A) / 50µs  
Vin 24V, Vout 48V



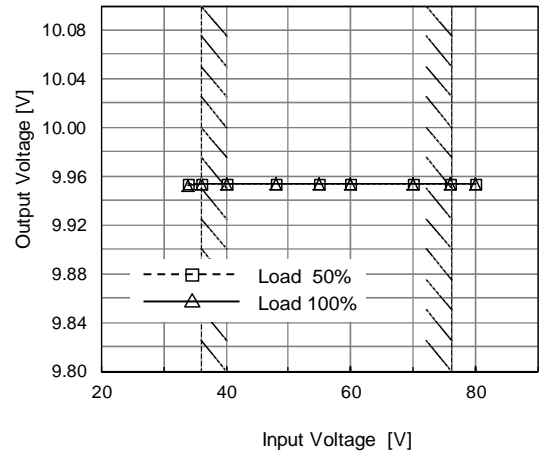
(f) Dynamic Load Response  
Load 100%(5.3A)→Load 50%(2.65A) / 50µs  
Vin 24V, Vout 48V

## 5.5.8 CHS3004810

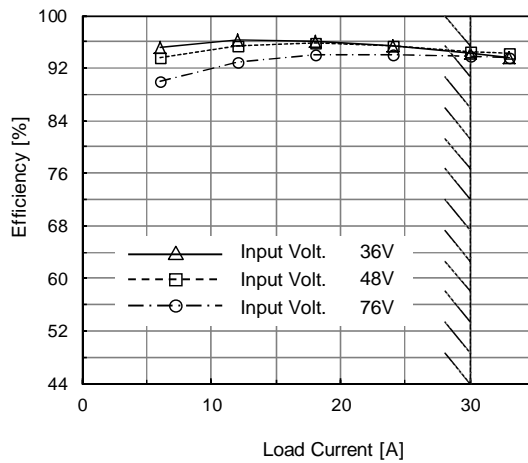
Fig.5.5.8  
Overview of  
CHS3004810 at 25°C



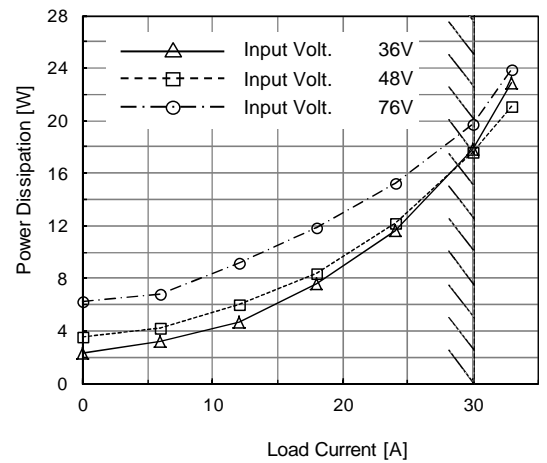
(a) Load Regulation



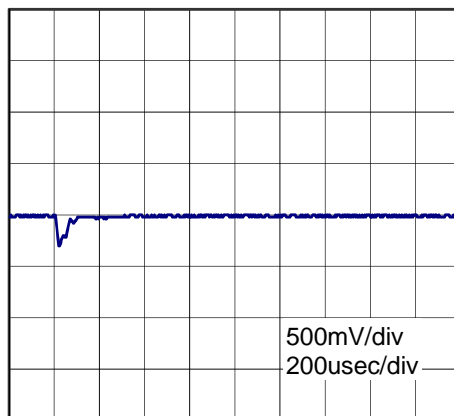
(b) Line Regulation



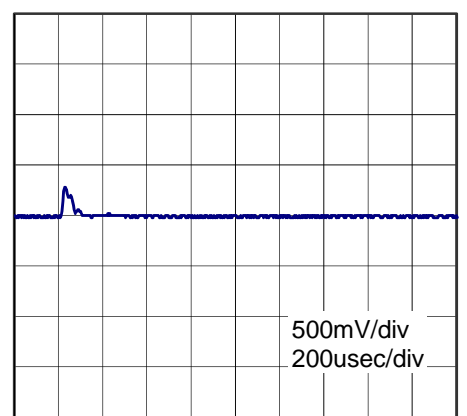
(c) Efficiency (by Load Current)



(d) Power Dissipation (by Load Current)



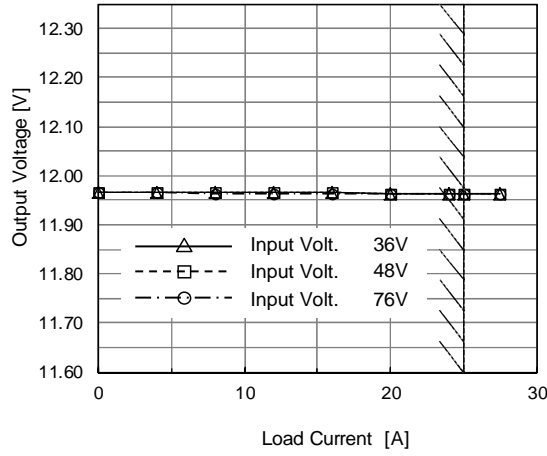
(e) Dynamic Load Response  
Load 50%(15A)→Load 100%(30A)/50us  
Vin 48V, Vout 10V



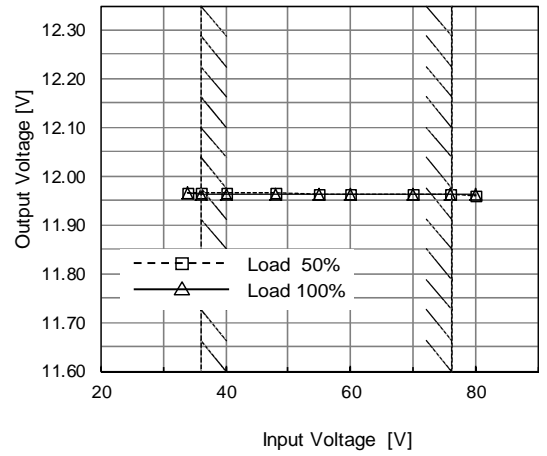
(f) Dynamic Load Response  
Load 100%(30A)→Load 50%(15A)/50us  
Vin 48V, Vout 10V

### 5.5.9 CHS3004812

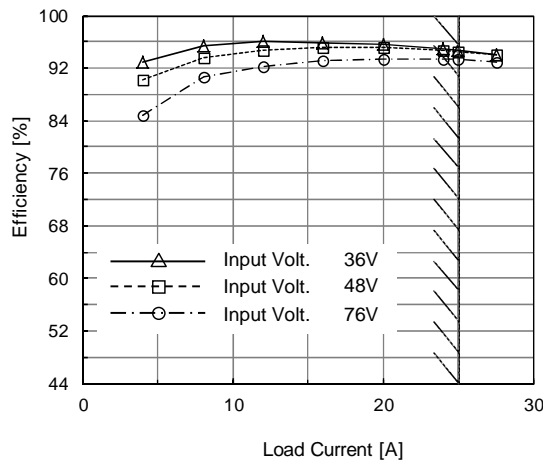
Fig.5.5.9  
Overview of  
CHS3004812 at 25°C



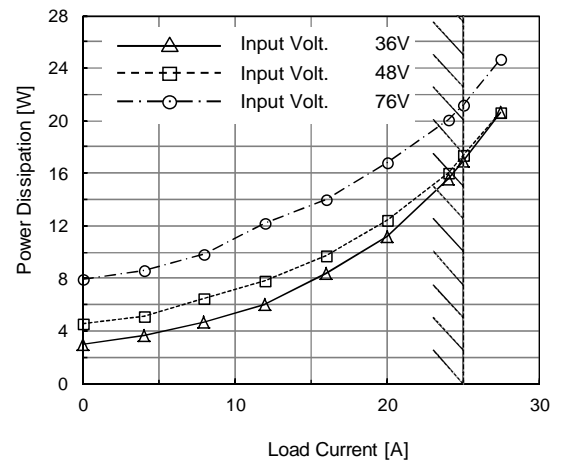
(a) Load Regulation



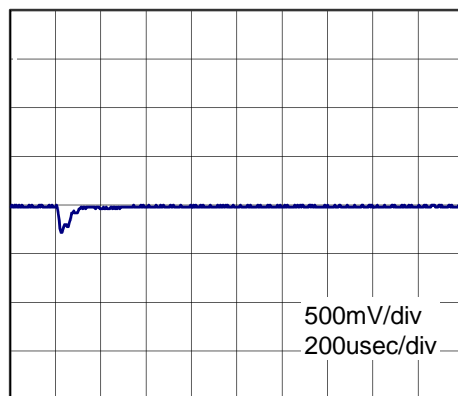
(b) Line Regulation



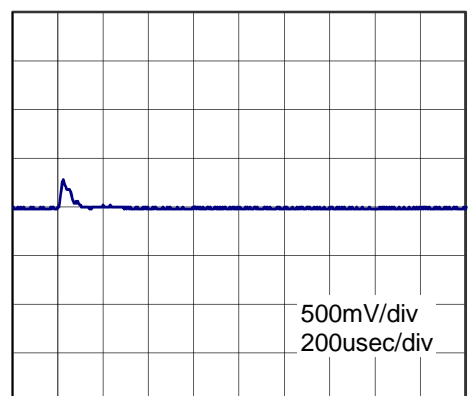
(c) Efficiency ( by Load Current )



(d) Power Dissipation( by Load Current )



(e) Dynamic Load Response  
Load 50%(12.5A)→Load 100%(25A) / 50us  
Vin 48V, Vout 12V

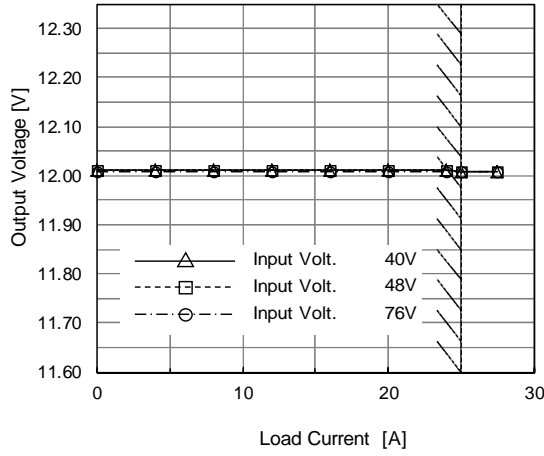


(f) Dynamic Load Response  
Load 100%(25A)→Load 50%(12.5A) / 50us  
Vin 48V, Vout 12V

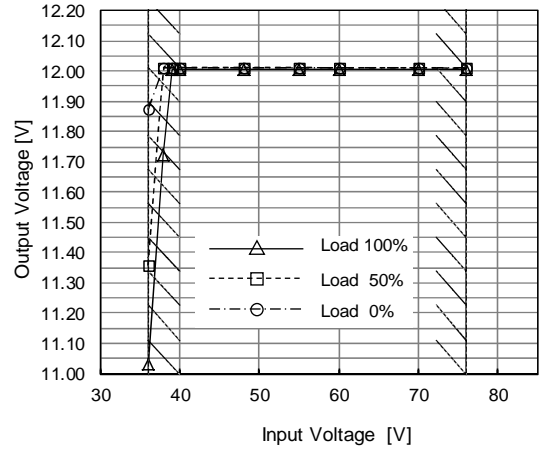


### 5.5.10 CHS3004812H

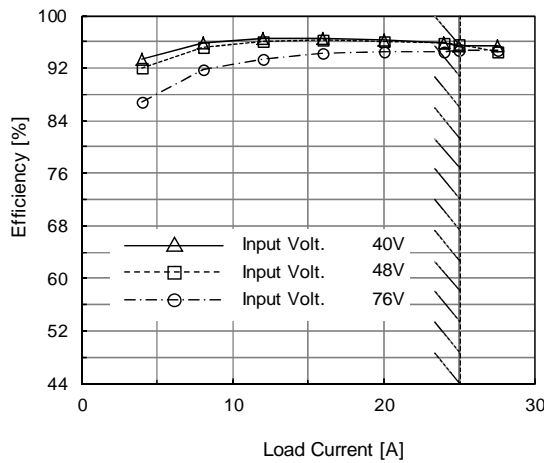
Fig.5.5.10  
Overview of  
CHS3004812H at 25°C



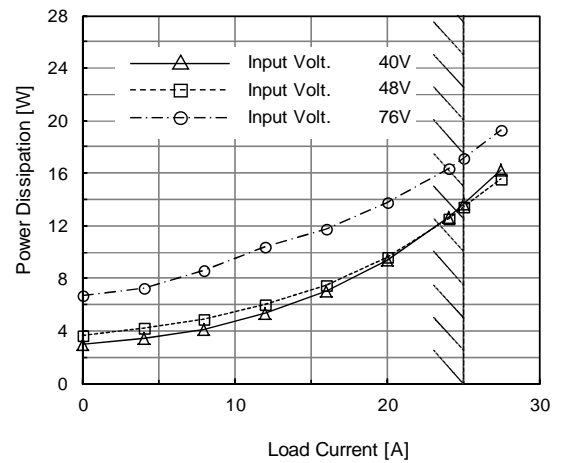
(a) Load Regulation



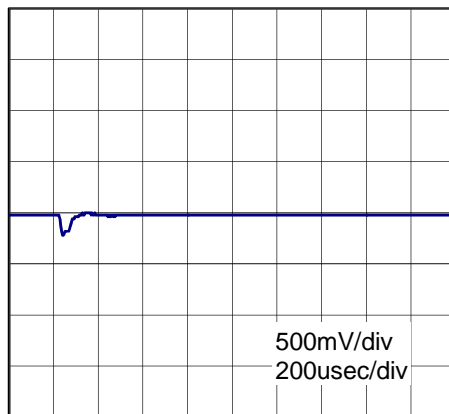
(b) Line Regulation



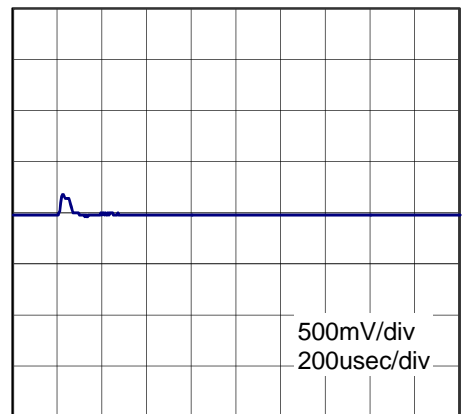
(c) Efficiency ( by Load Current )



(d) Power Dissipation( by Load Current )



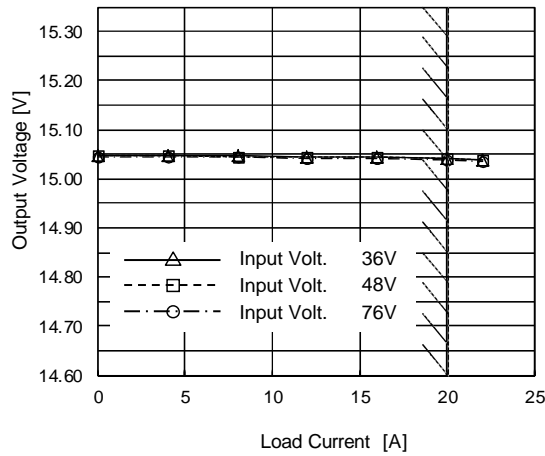
(e) Dynamic Load Response  
Load 50%(12.5A)→Load 100%(25A)/50us  
Vin 48V,Vout 12V



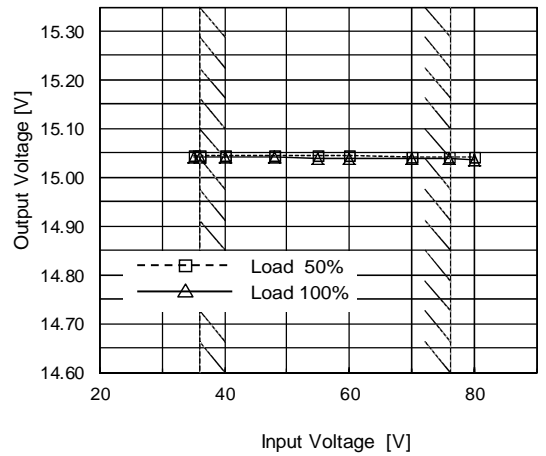
(f) Dynamic Load Response  
Load 100%(25A)→Load 50%(12.5A)/50us  
Vin 48V,Vout 12V

### 5.5.11 CHS3004815

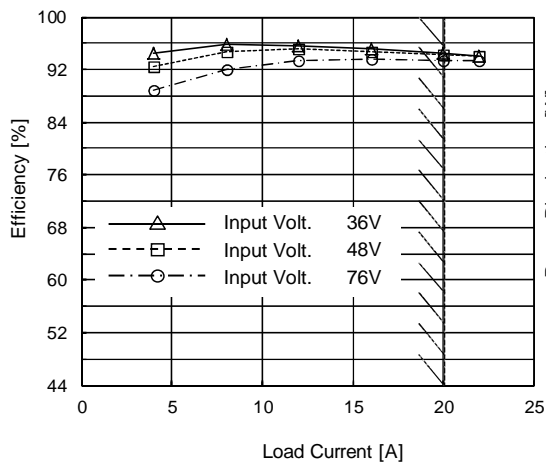
Fig.5.5.11  
Overview of  
CHS3004815 at 25°C



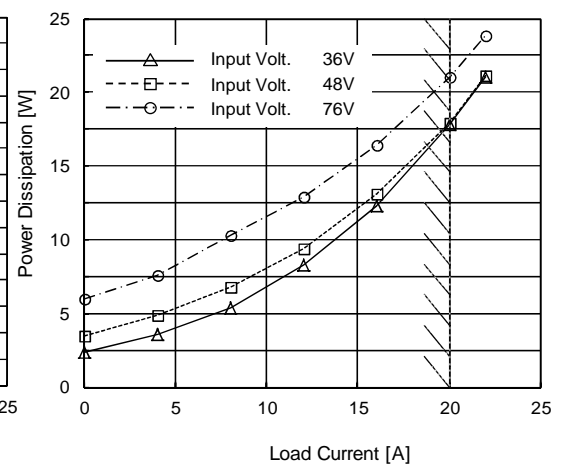
(a) Load Regulation



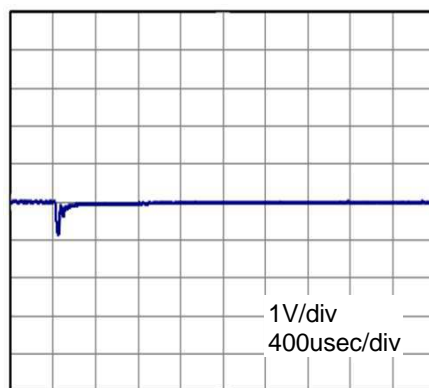
(b) Line Regulation



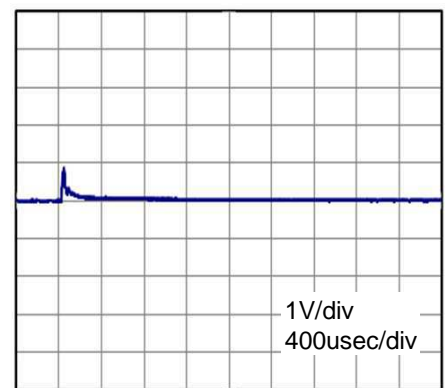
(c) Efficiency (by Load Current)



(d) Power Dissipation (by Load Current)



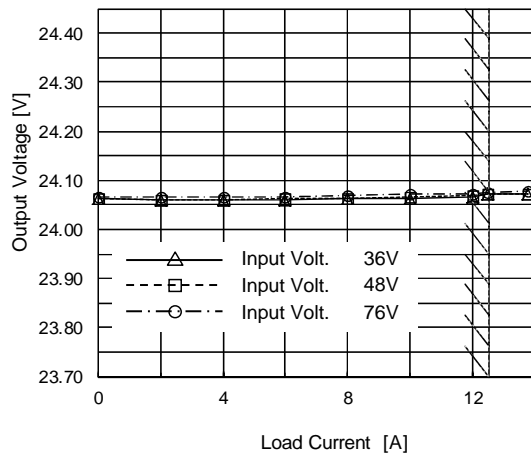
(e) Dynamic Load Response  
Load 50%(10A)→Load 100%(20A) / 50us  
Vin 48V, Vout 15V



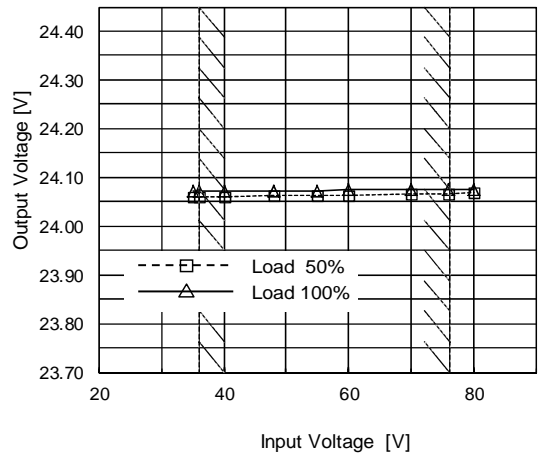
(f) Dynamic Load Response  
Load 100%(20A)→Load 50%(10A) / 50us  
Vin 48V, Vout 15V

## 5.5.12 CHS3004824

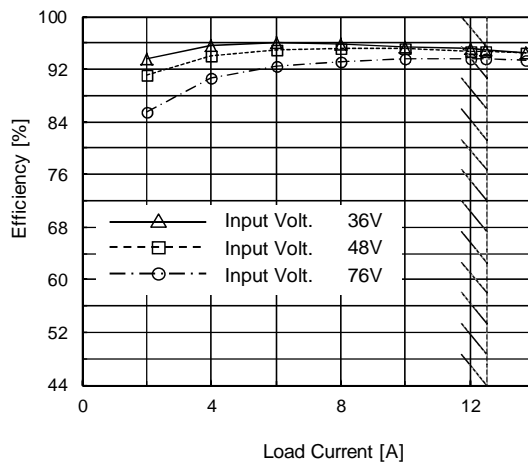
Fig.5.5.12  
Overview of  
CHS3004824 at 25°C



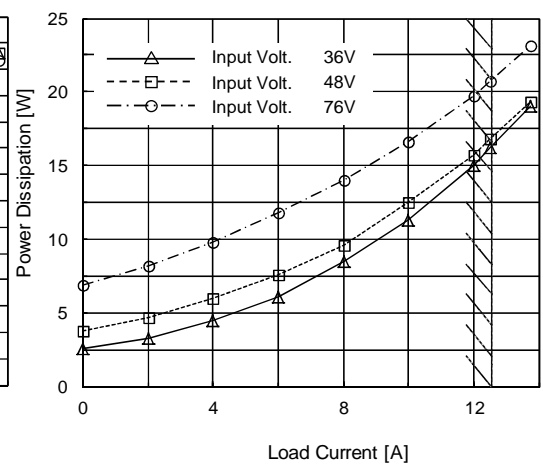
(a) Load Regulation



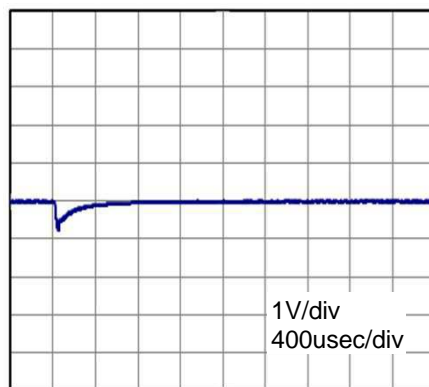
(b) Line Regulation



(c) Efficiency (by Load Current)

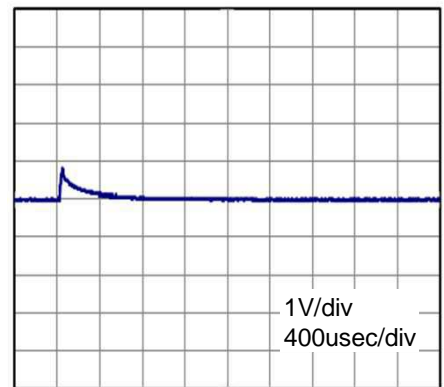


(d) Power Dissipation (by Load Current)



(e) Dynamic Load Response

Load 50%(6.25A)→Load 100%(12.5A) / 50us  
Vin 48V, Vout 24V

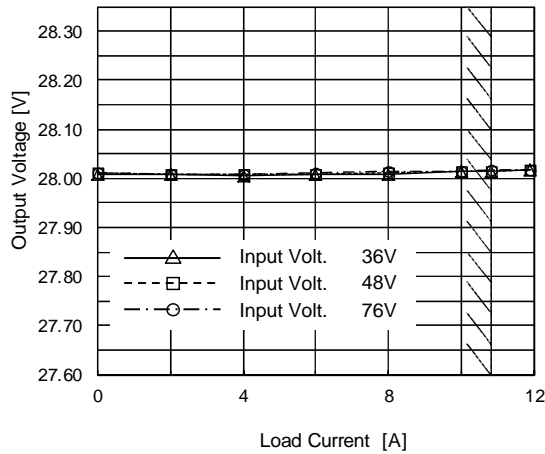


(f) Dynamic Load Response

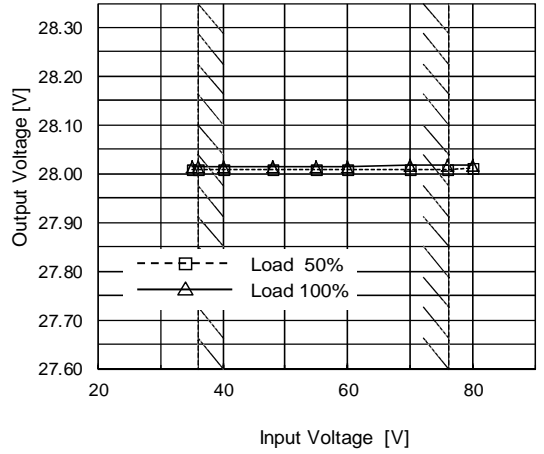
Load 100%(12.5A)→Load 50%(6.25A) / 50us  
Vin 48V, Vout 24V

### 5.5.13 CHS3004828

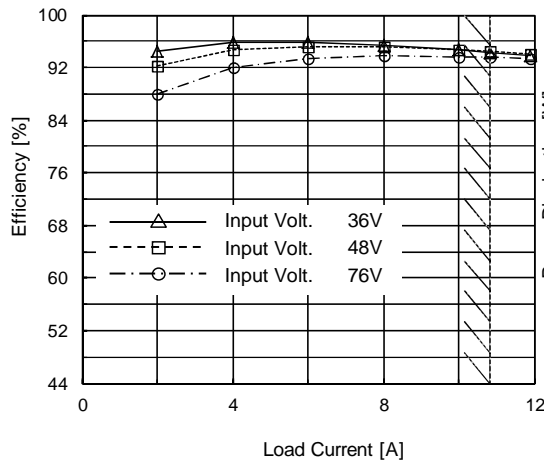
Fig.5.5.13  
Overview of  
CHS3004828 at 25°C



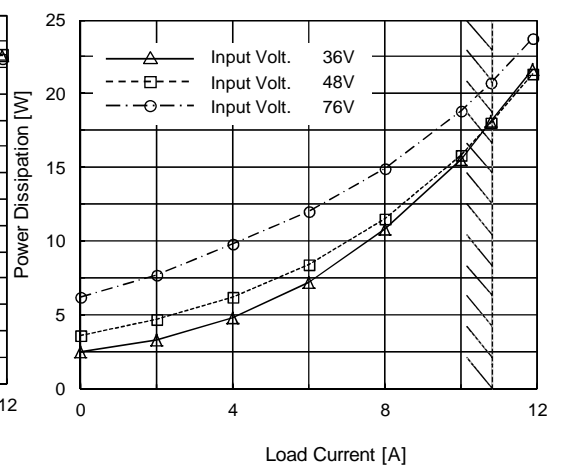
(a) Load Regulation



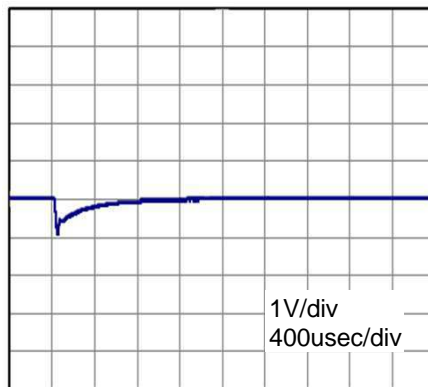
(b) Line Regulation



(c) Efficiency (by Load Current)

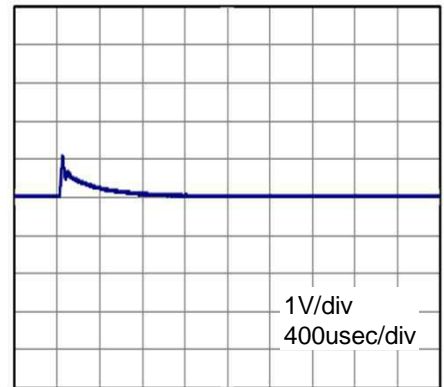


(d) Power Dissipation (by Load Current)



(e) Dynamic Load Response

Load 50%(5.4A)→Load 100%(10.8A) / 50us  
Vin 48V, Vout 28V

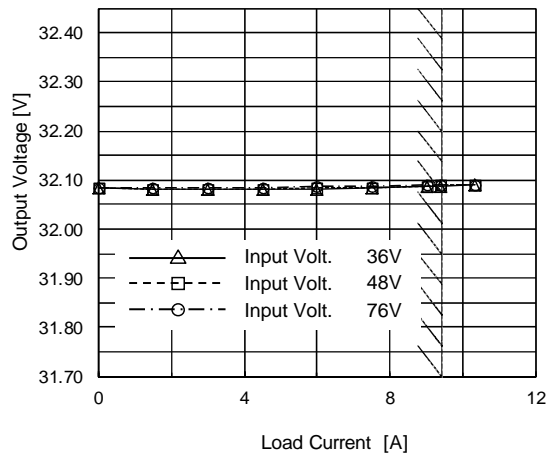


(f) Dynamic Load Response

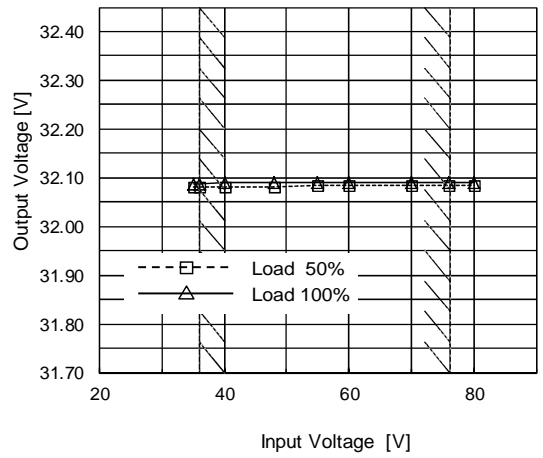
Load 100%(10.8A)→Load 50%(5.4A) / 50us  
Vin 48V, Vout 28V

### 5.5.14 CHS3004832

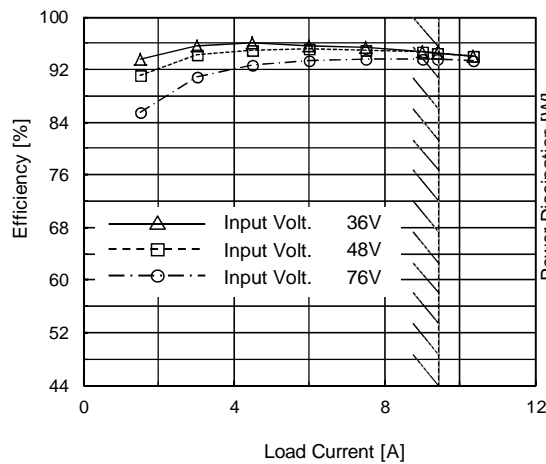
Fig.5.5.14  
Overview of  
CHS3004832 at 25°C



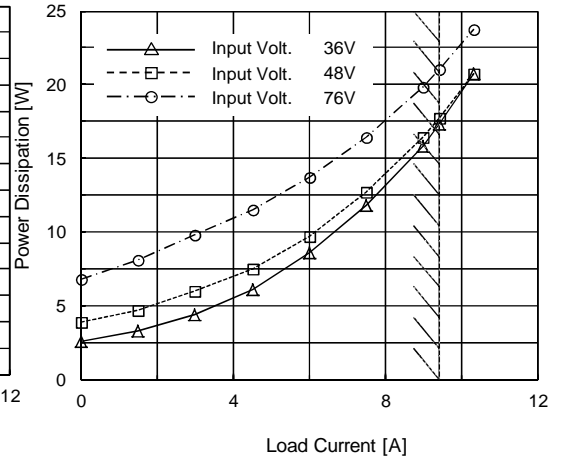
(a) Load Regulation



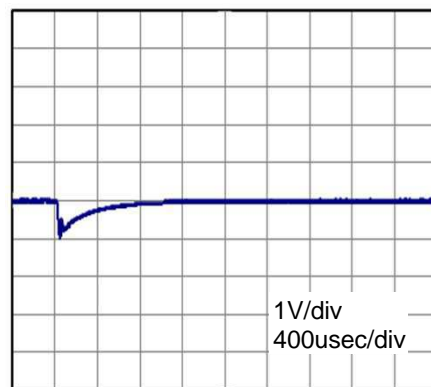
(b) Line Regulation



(c) Efficiency ( by Load Current )

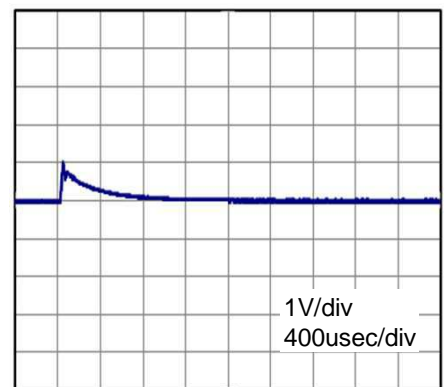


(d) Power Dissipation( by Load Current )



(e) Dynamic Load Response

Load 50%(4.7A)→Load 100%(9.4A) / 50us  
Vin 48V, Vout 32V

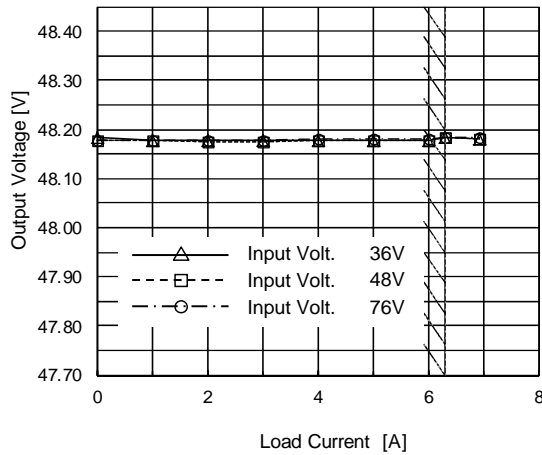


(f) Dynamic Load Response

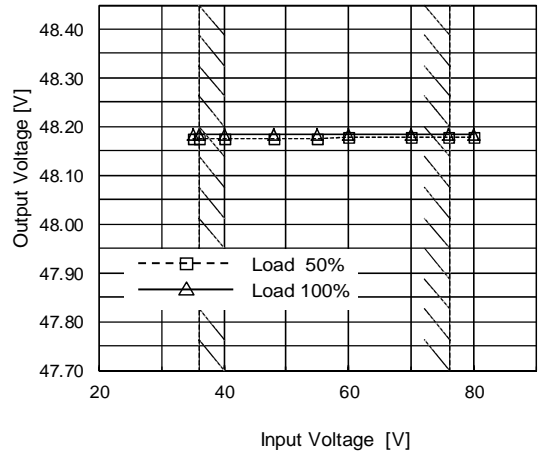
Load 100%(9.4A)→Load 50%(4.7A) /  
50us Vin 48V, Vout 32V

### 5.5.15 CHS3004848

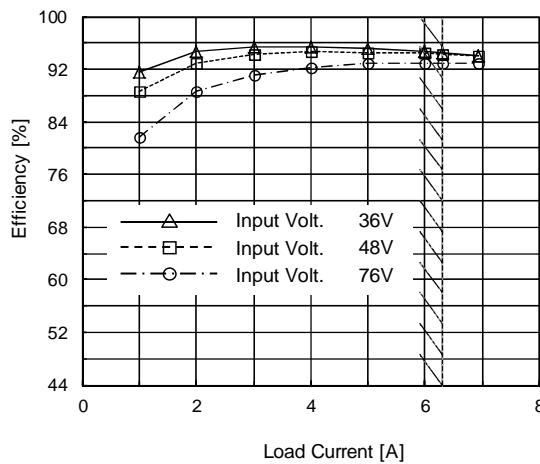
Fig.5.5.15  
Overview of  
CHS3004848 at 25°C



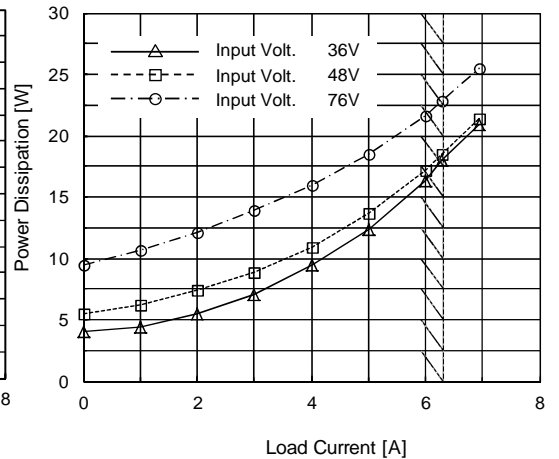
(a) Load Regulation



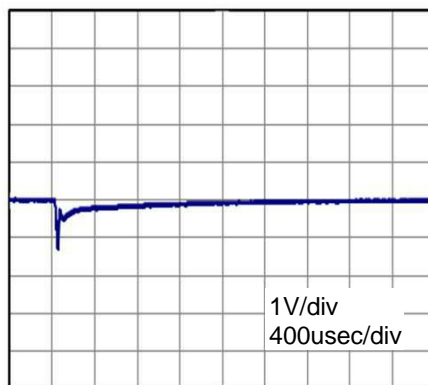
(b) Line Regulation



(c) Efficiency (by Load Current)

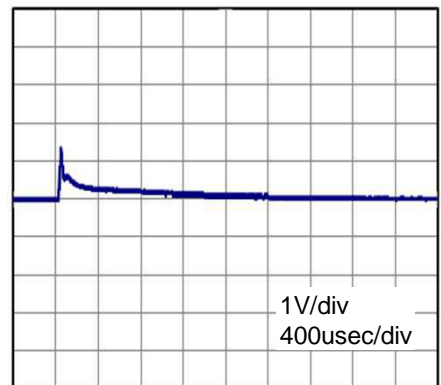


(d) Power Dissipation (by Load Current)



(e) Dynamic Load Response

Load 50%(3.15A)→Load 100%(6.3A) / 50us  
Vin 48V, Vout 48V



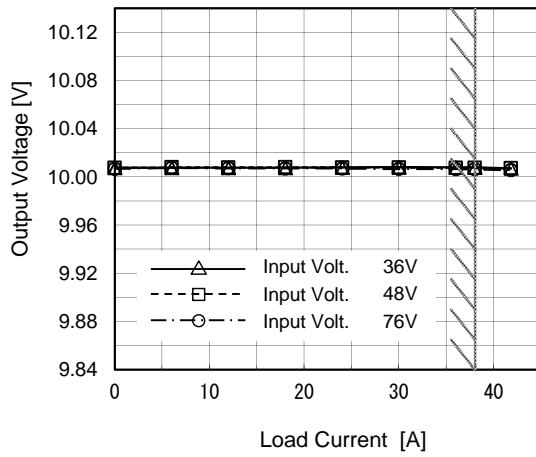
(f) Dynamic Load Response

Load 100%(6.3A)→Load 50%(3.15A) / 50us  
Vin 48V, Vout 48V

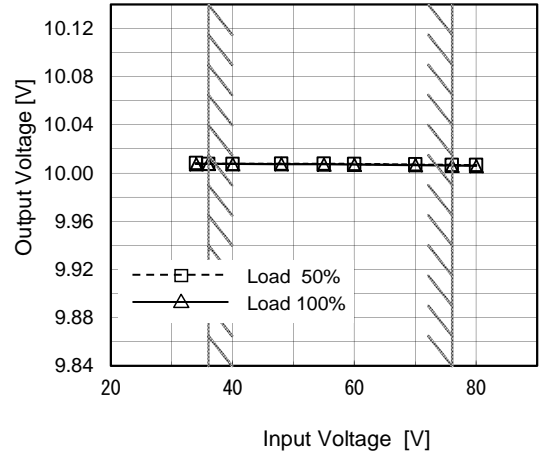
## 5.6 CHS380

### 5.6.1 CHS3804810

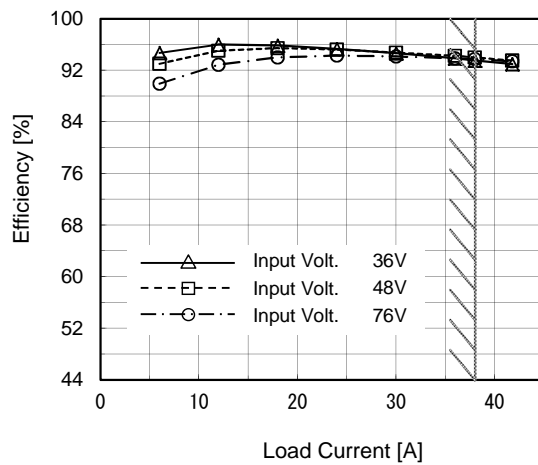
Fig.5.6.1  
Overview of  
CHS3804810 at 25°C



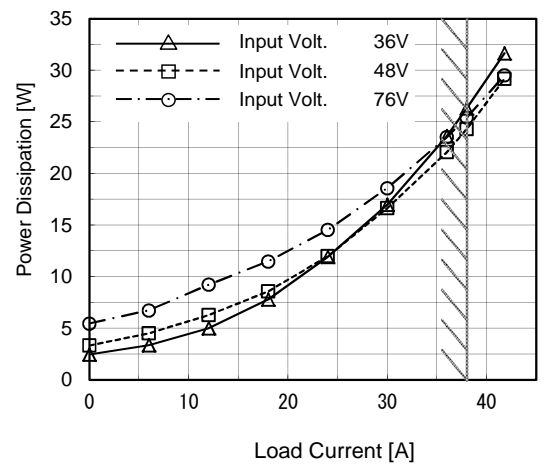
(a) Load Regulation



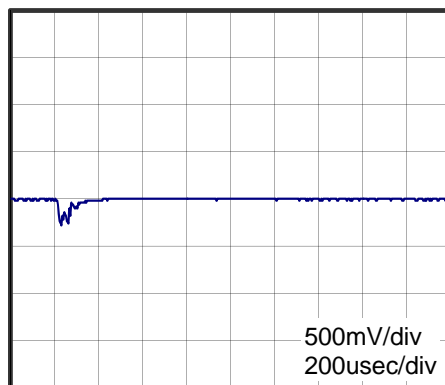
(b) Line Regulation



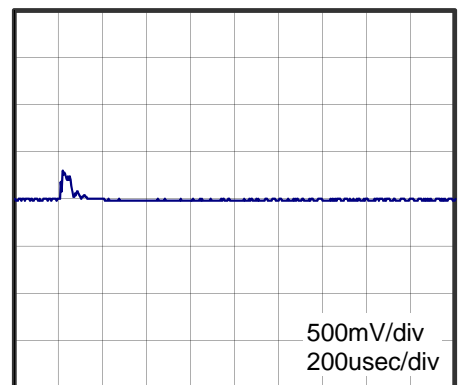
(c) Efficiency ( by Load Current )



(d) Power Dissipation( by Load Current )



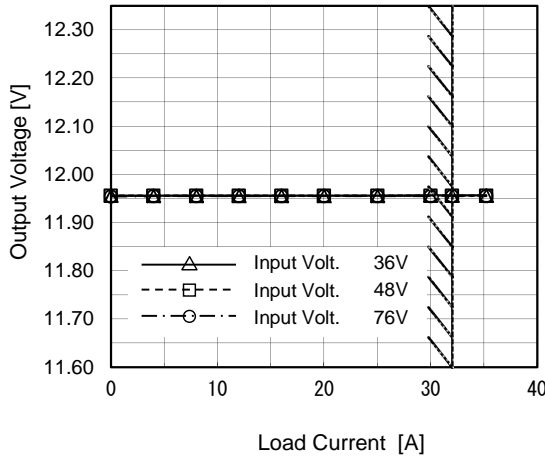
(e) Dynamic Load Response  
Load 50%(19A)→Load 100%(38A)/50us  
Vin 48V, Vout 10V



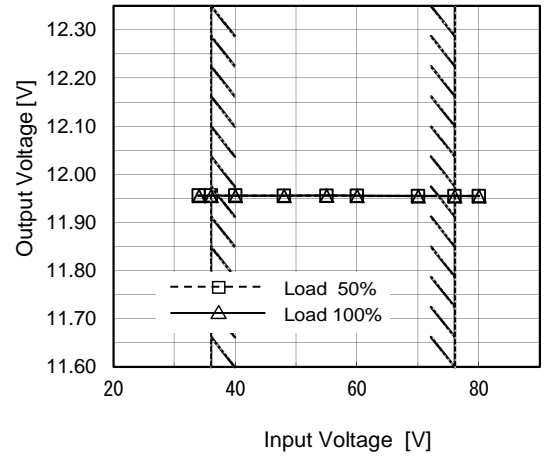
(f) Dynamic Load Response  
Load 100%(38A)→Load 50%(19A)/50us  
Vin 48V, Vout 10V

## 5.6.2 CHS3804812

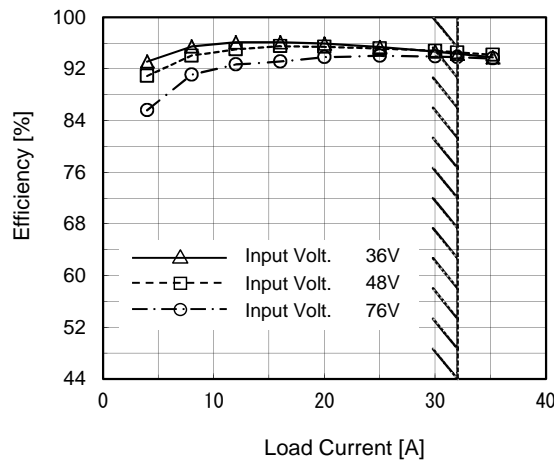
Fig.5.6.2  
Overview of  
CHS3804812 at 25°C



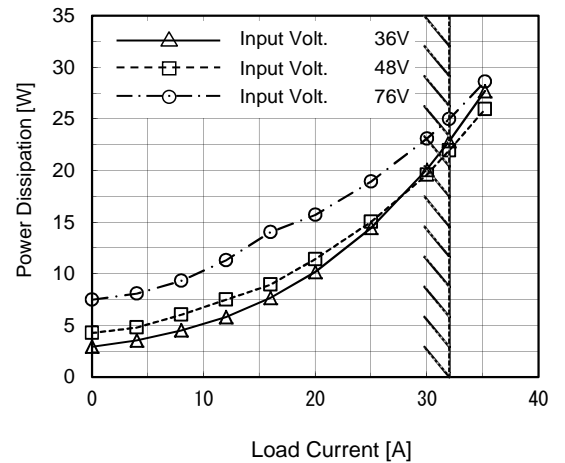
(a) Load Regulation



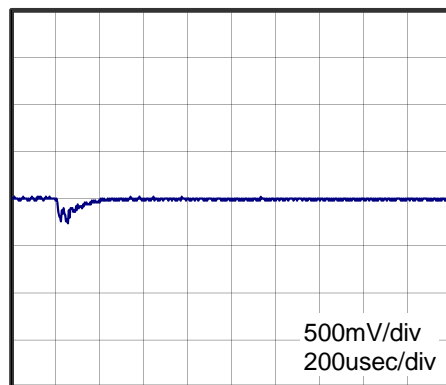
(b) Line Regulation



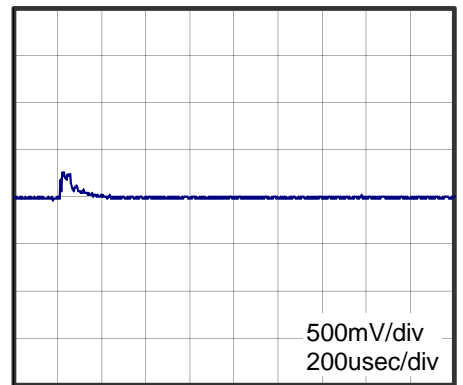
(c) Efficiency ( by Load Current )



(d) Power Dissipation( by Load Current )



(e) Dynamic Load Response  
Load 50%(16A)→Load 100%(32A)∕50us  
Vin 48V, Vout 12V

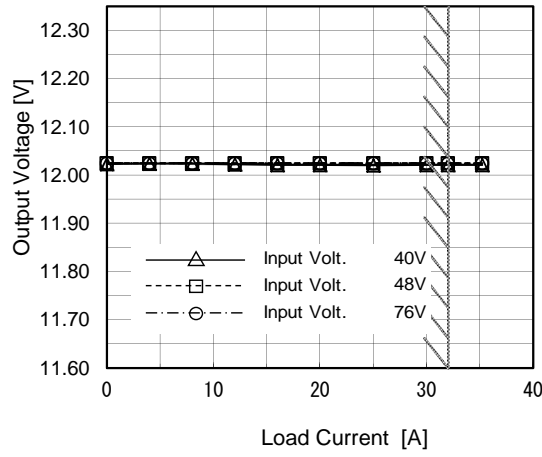


(f) Dynamic Load Response  
Load 100%(32A)→Load 50%(16A)∕50us  
Vin 48V, Vout 12V

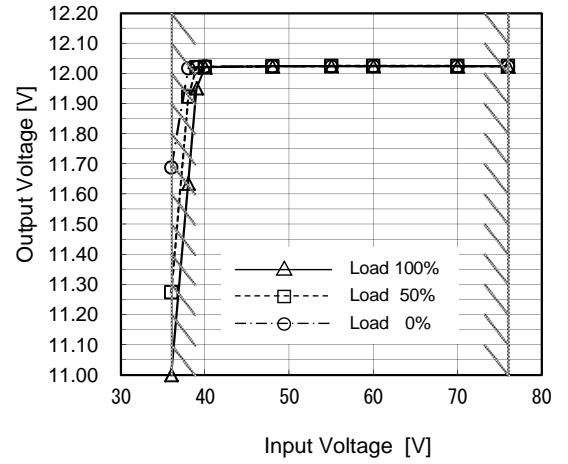


### 5.6.3 CHS3804812H

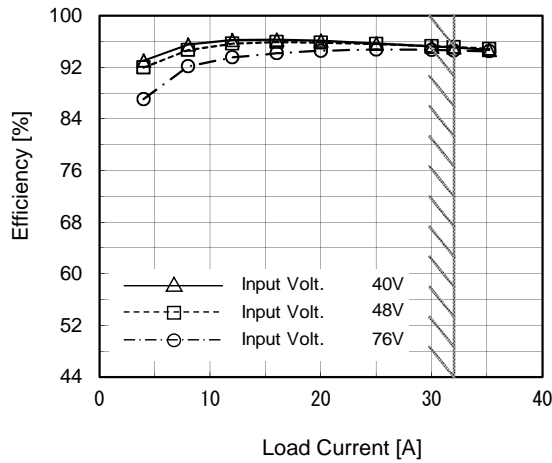
Fig.5.6.3  
Overview of  
CHS3804812H at 25°C



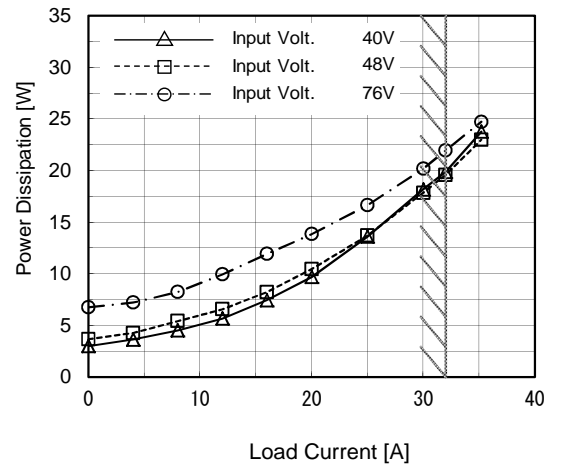
(a) Load Regulation



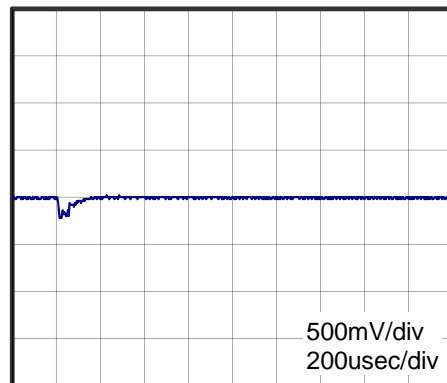
(b) Line Regulation



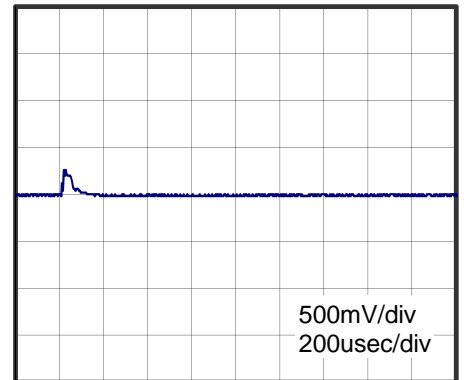
(c) Efficiency (by Load Current)



(d) Power Dissipation (by Load Current)



(e) Dynamic Load Response  
Load 50%(16A)→Load 100%(32A)/50us  
Vin 48V, Vout 12V

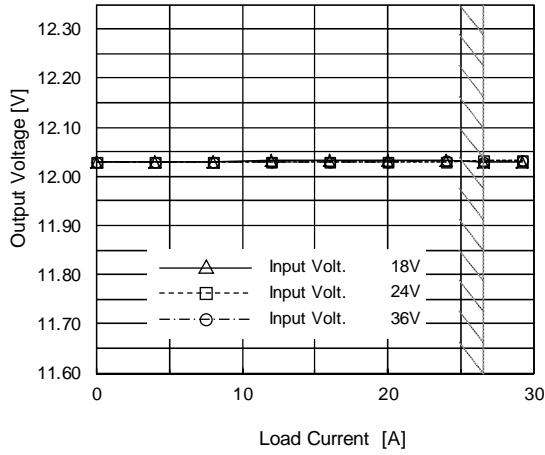


(f) Dynamic Load Response  
Load 100%(32A)→Load 50%(16A)/50us  
Vin 48V, Vout 12V

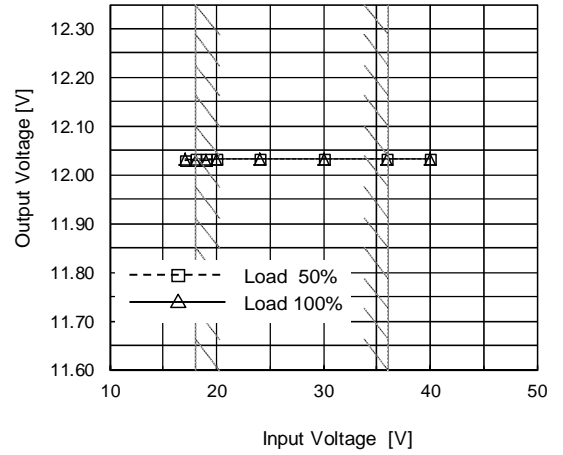
5.7 CHS400

5.7.1 CHS4002412

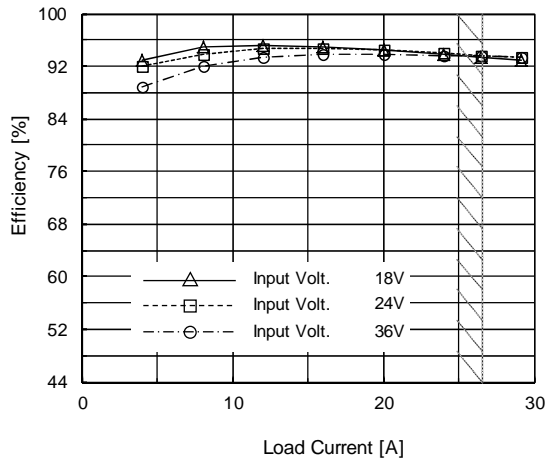
Fig.5.7.1  
Overview of  
CHS4002412 at 25°C



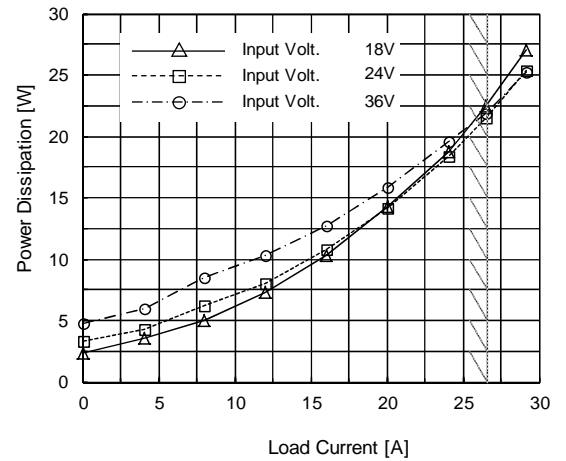
(a) Load Regulation



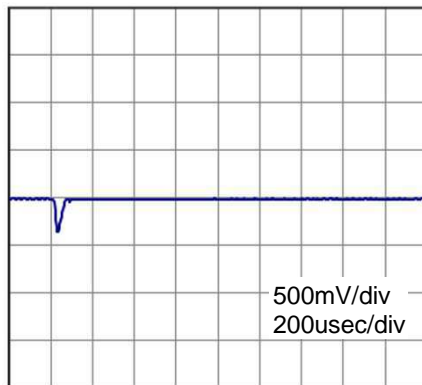
(b) Line Regulation



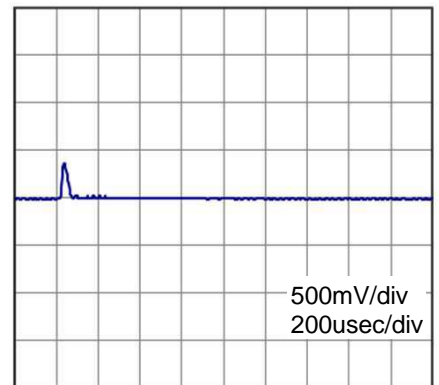
(c) Efficiency ( by Load Current )



(d) Power Dissipation( by Load Current )



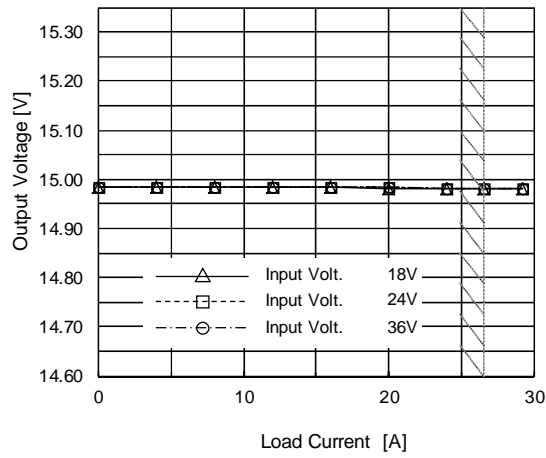
(e) Dynamic Load Response  
Load 50%(13.25A)→Load 100%(26.5A)/50us  
Vin 24V,Vout 12V



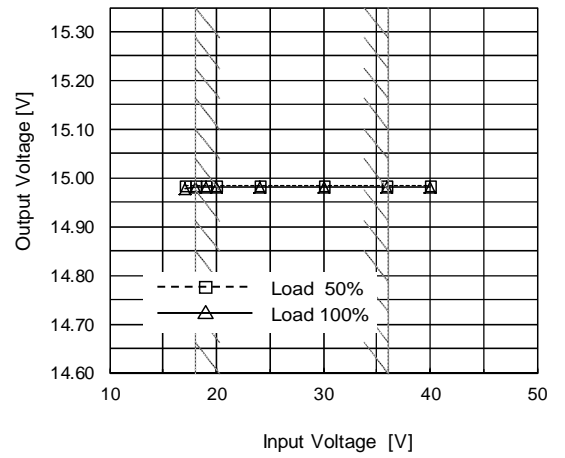
(f) Dynamic Load Response  
Load 100%(26.5A)→Load 50%(13.25A)/50us  
Vin 24V,Vout 12V

## 5.7.2 CHS4002415

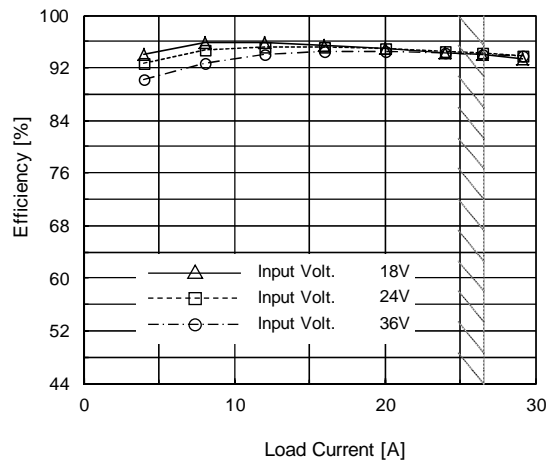
Fig.5.7.2  
Overview of  
CHS4002415 at 25°C



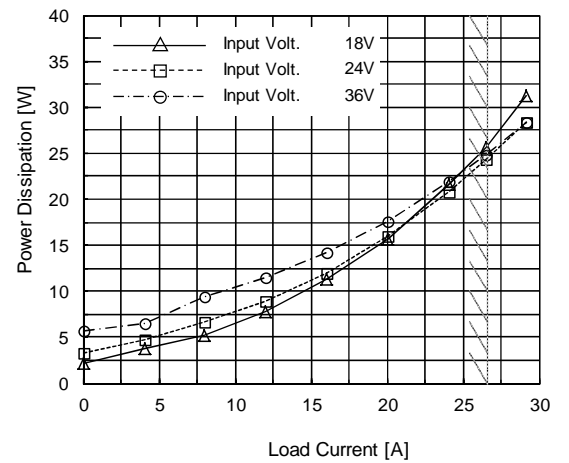
(a) Load Regulation



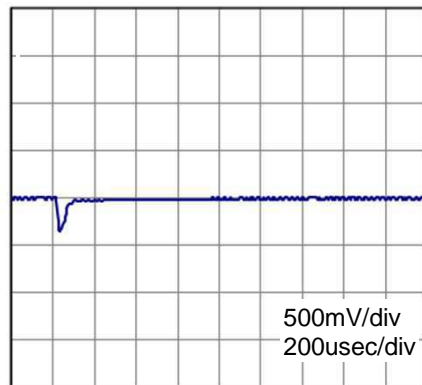
(b) Line Regulation



(c) Efficiency (by Load Current)

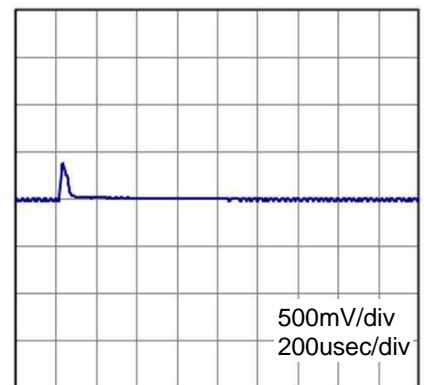


(d) Power Dissipation (by Load Current)



(e) Dynamic Load Response

Load 50%(13.25A)→Load 100%(26.5A)/50us  
Vin 24V, Vout 15V

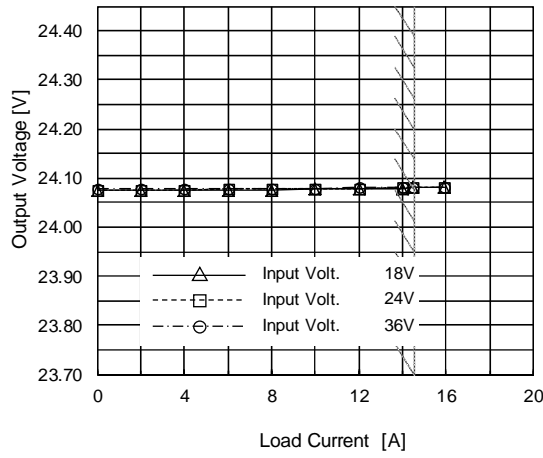


(f) Dynamic Load Response

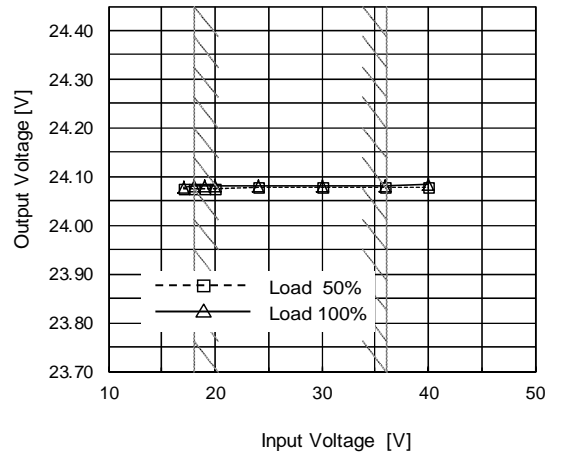
Load 100%(26.5A)→Load 50%(13.25A)/50us  
Vin 24V, Vout 15V

### 5.7.3 CHS4002424

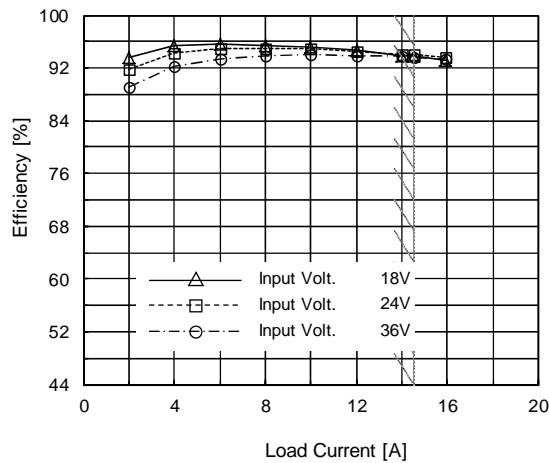
Fig.5.7.3  
Overview of  
CHS4002424 at 25°C



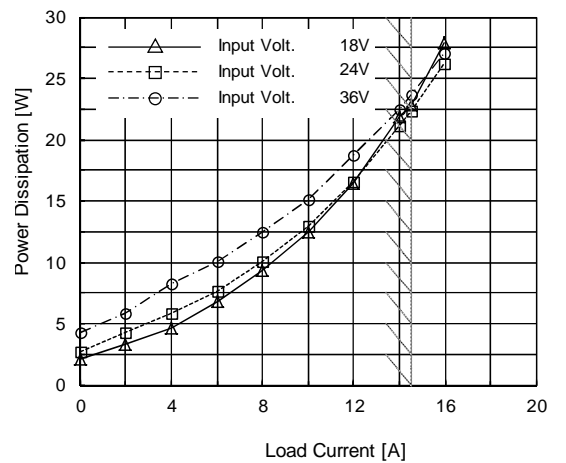
(a) Load Regulation



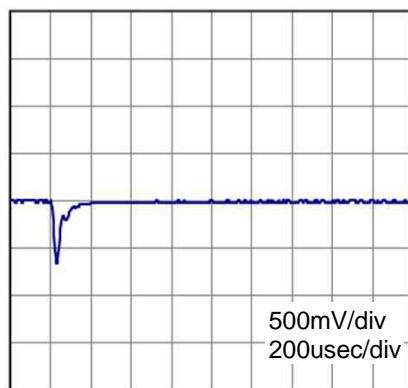
(b) Line Regulation



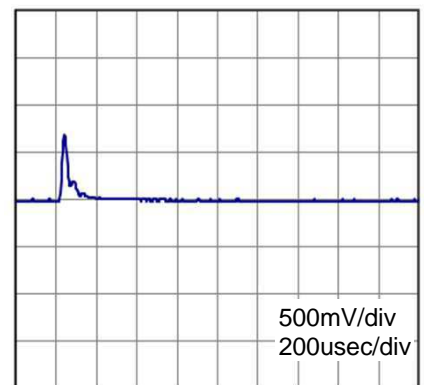
(c) Efficiency ( by Load Current )



(d) Power Dissipation( by Load Current )



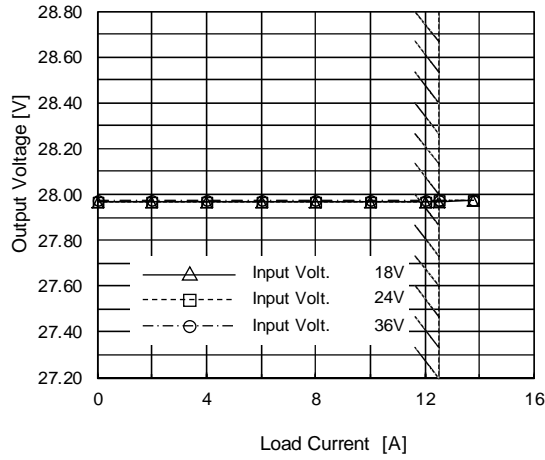
(e) Dynamic Load Response  
Load 50%(7.25A)→Load 100%(14.5A)/50us  
Vin 24V,Vout 24V



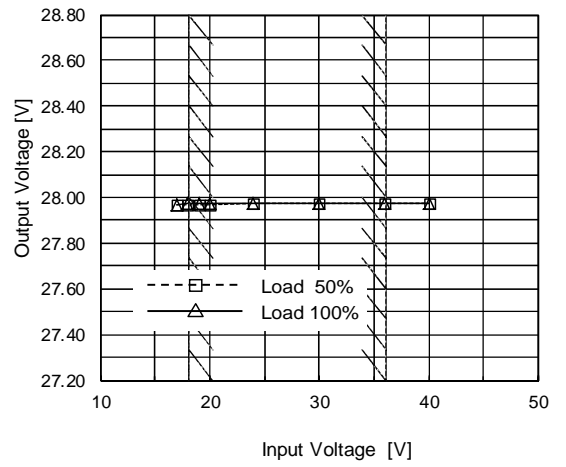
(f) Dynamic Load Response  
Load 100%(14.5A)→Load 50%(7.25A)/50us  
Vin 24V,Vout 24V

### 5.7.4 CHS4002428

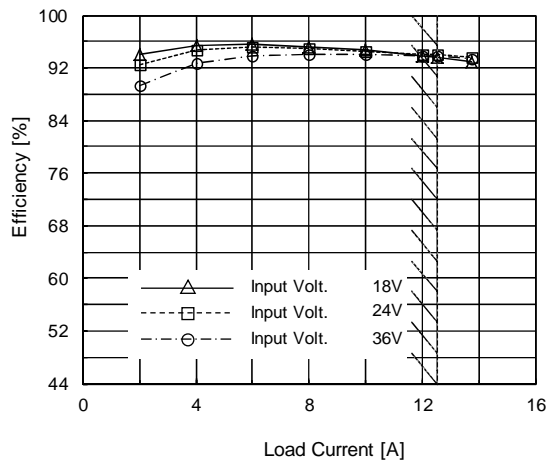
Fig.5.7.4  
Overview of  
CHS4002428 at 25°C



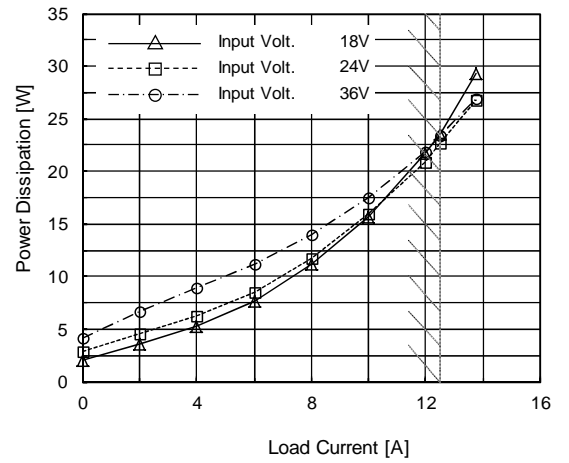
(a) Load Regulation



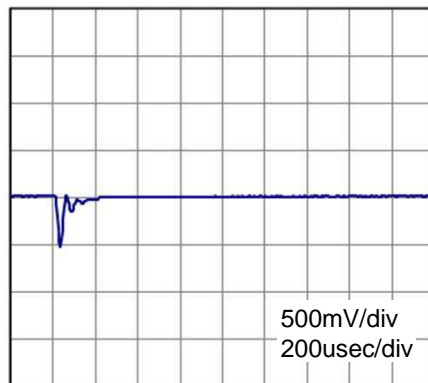
(b) Line Regulation



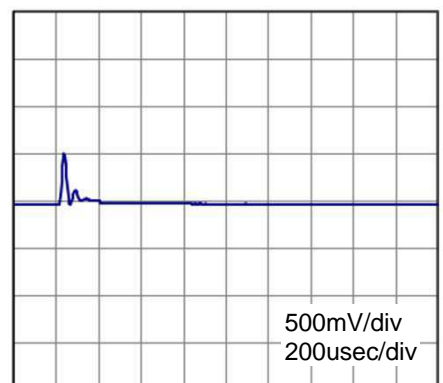
(c) Efficiency ( by Load Current )



(d) Power Dissipation( by Load Current )



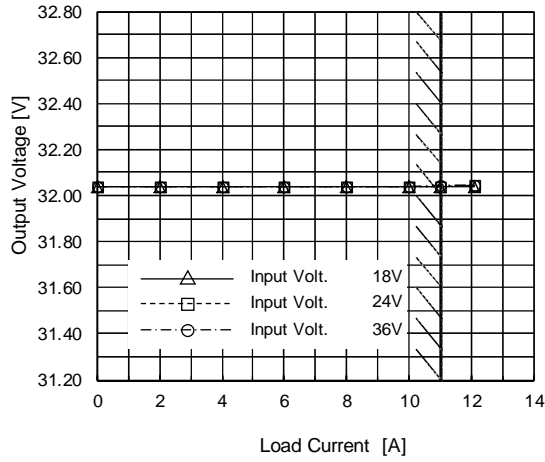
(e) Dynamic Load Response  
Load 50%(6.25A)→Load 100%(12.5A)/50us  
Vin 24V,Vout 28V



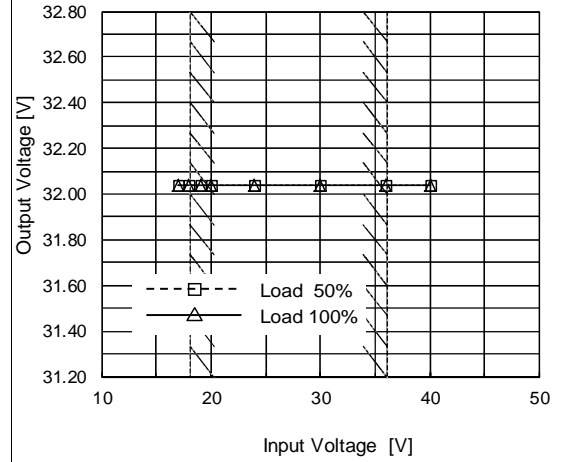
(f) Dynamic Load Response  
Load 100%(12.5A)→Load 50%(6.25A)/50us  
Vin 24V,Vout 28V

## 5.7.5 CHS4002432

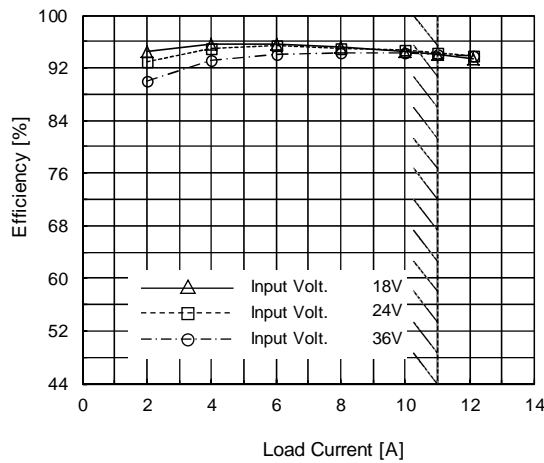
Fig.5.7.5  
Overview of  
CHS4002432 at 25°C



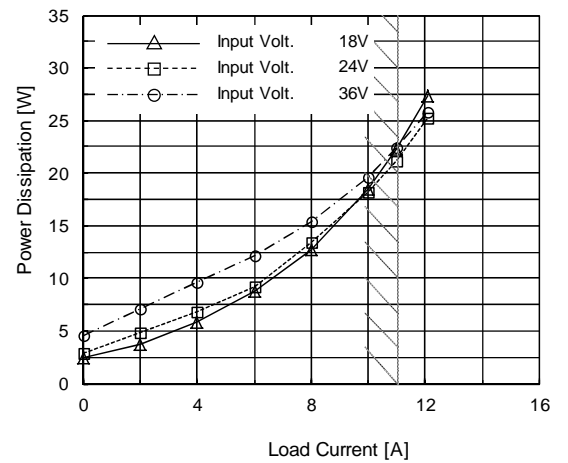
(a) Load Regulation



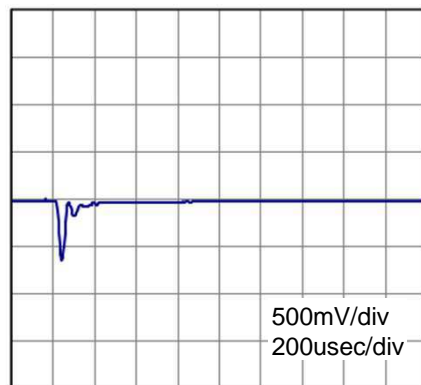
(b) Line Regulation



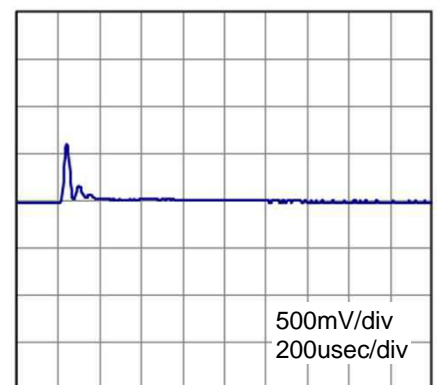
(c) Efficiency ( by Load Current )



(d) Power Dissipation( by Load Current )



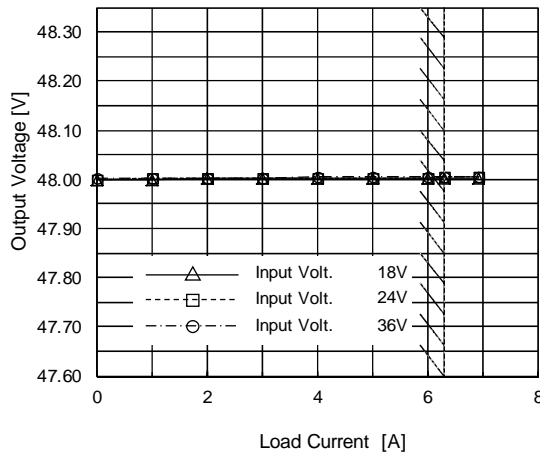
(e) Dynamic Load Response  
Load 50%(5.5A)→Load 100%(11A)/50us  
Vin 24V,Vout 32V



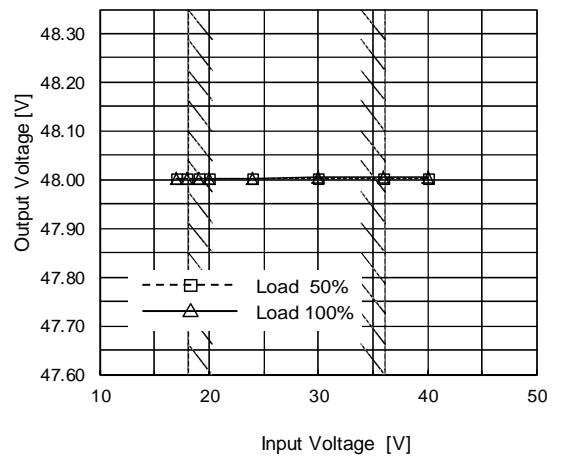
(f) Dynamic Load Response  
Load 100%(11A)→Load 50%(5.5A)/50us  
Vin 24V,Vout 32V

## 5.7.6 CHS4002448

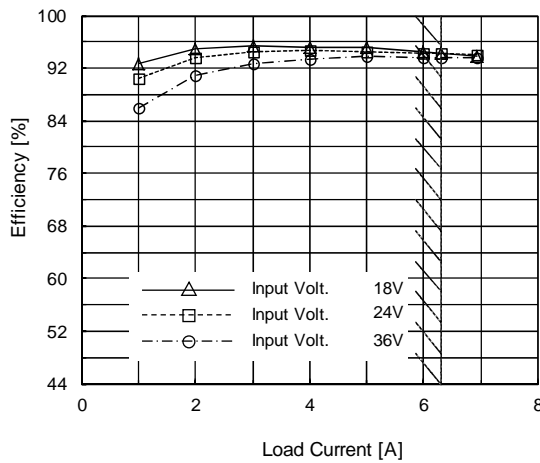
Fig.5.7.6  
Overview of  
CHS4002448 at 25°C



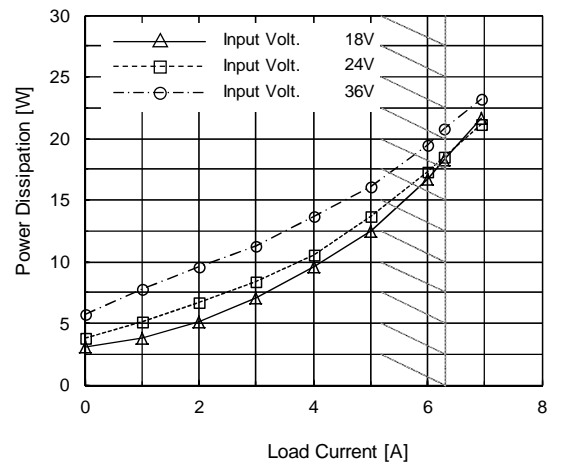
(a) Load Regulation



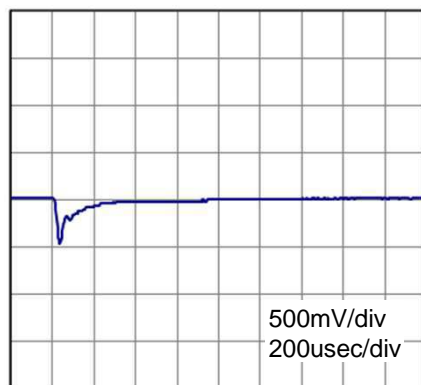
(b) Line Regulation



(c) Efficiency ( by Load Current )

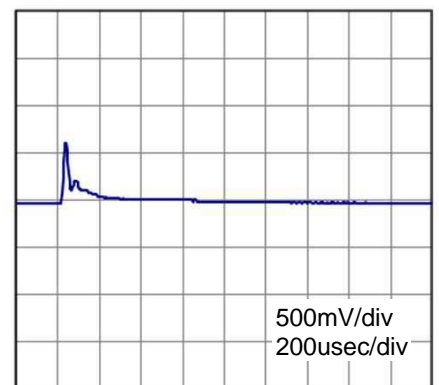


(d) Power Dissipation( by Load Current )



(e) Dynamic Load Response

Load 50%(3.15A)→Load 100%(6.3A)/50us  
Vin 24V, Vout 48V

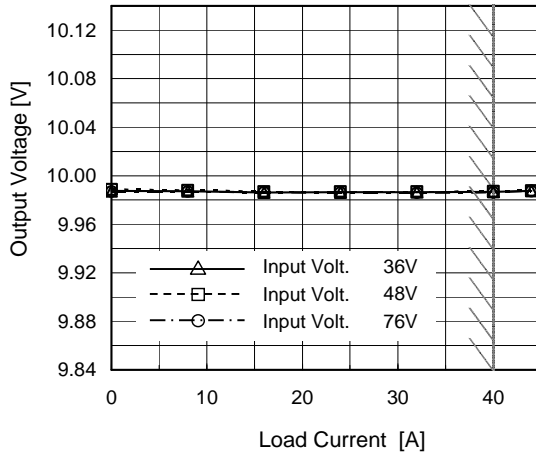


(f) Dynamic Load Response

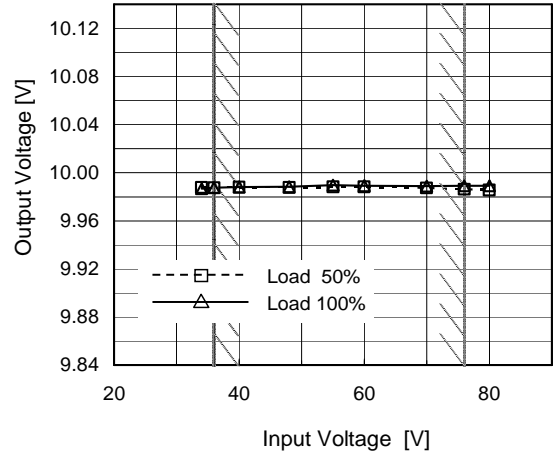
Load 100%(6.3A)→Load 50%(3.15A)/50us  
Vin 24V, Vout 48V

### 5.7.7 CHS4004810

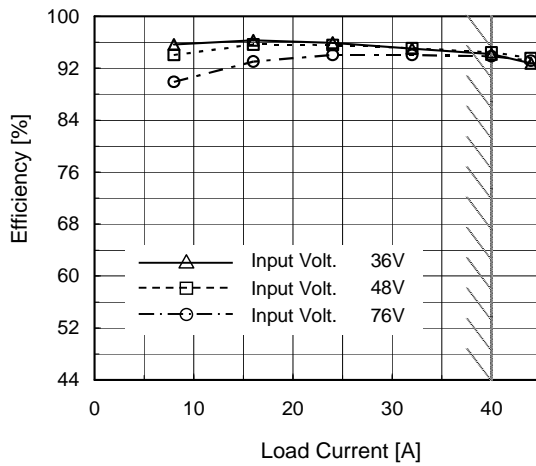
Fig.5.7.7  
Overview of  
CHS4004810 at 25°C



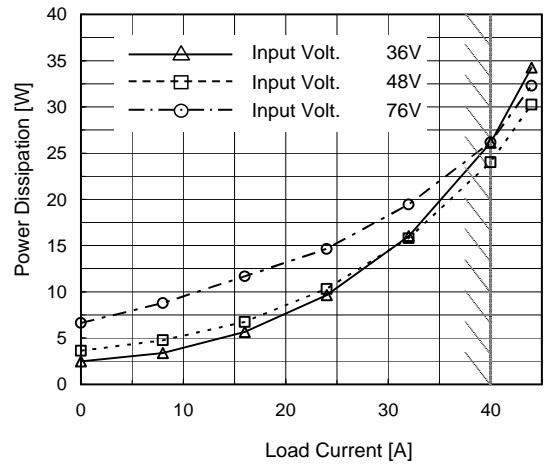
(a) Load Regulation



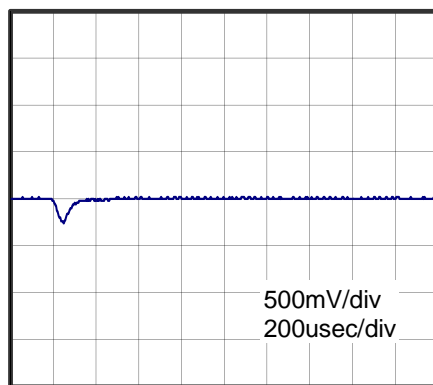
(b) Line Regulation



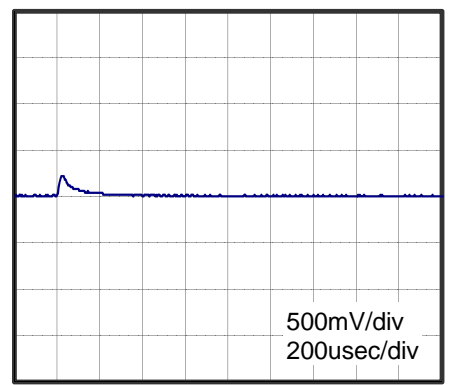
(c) Efficiency (by Load Current)



(d) Power Dissipation (by Load Current)



(e) Dynamic Load Response  
Load 50%(20A)→Load 100%(40A)/50us  
Vin 48V, Vout 10V

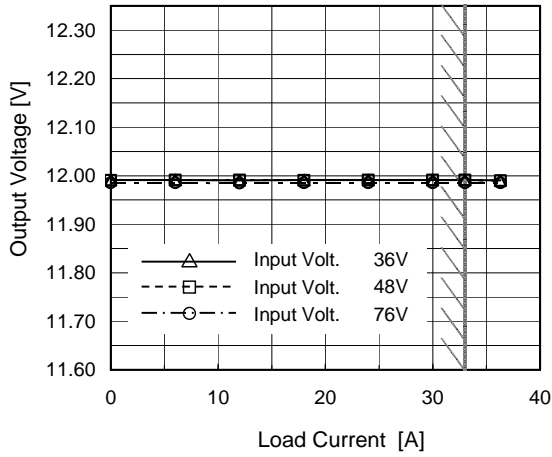


(f) Dynamic Load Response  
Load 100%(40A)→Load 50%(20A)/50us  
Vin 48V, Vout 10V

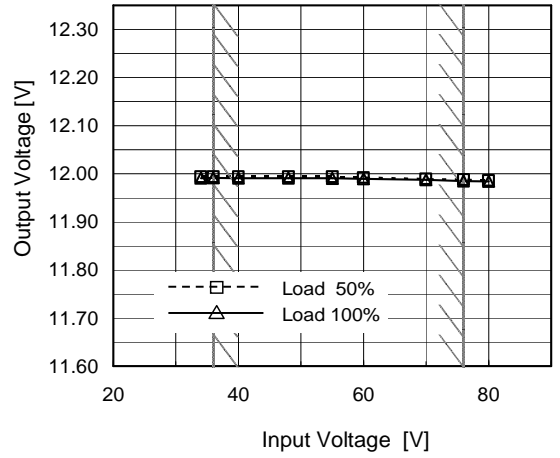


### 5.7.8 CHS4004812

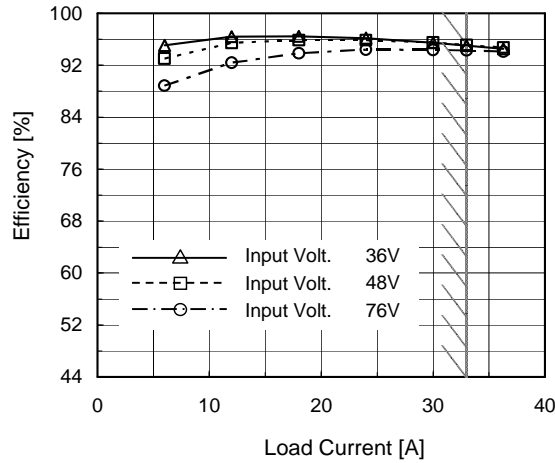
Fig.5.7.8  
Overview of  
CHS4004812 at 25°C



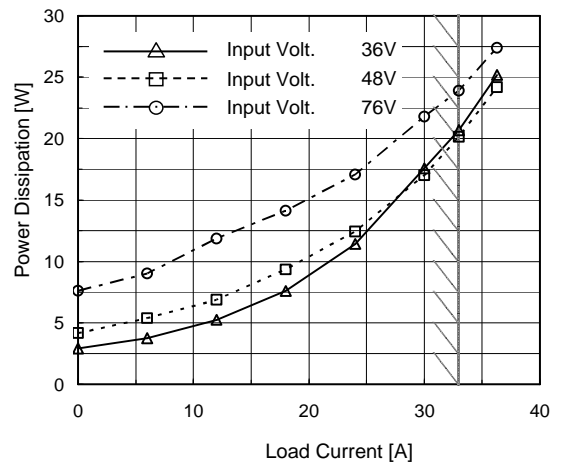
(a) Load Regulation



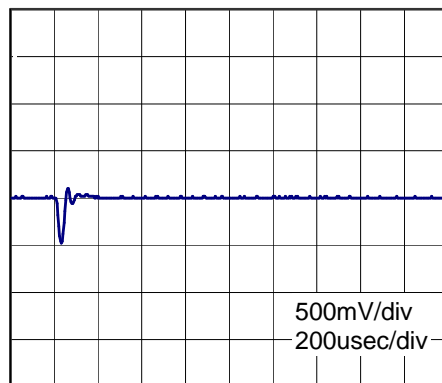
(b) Line Regulation



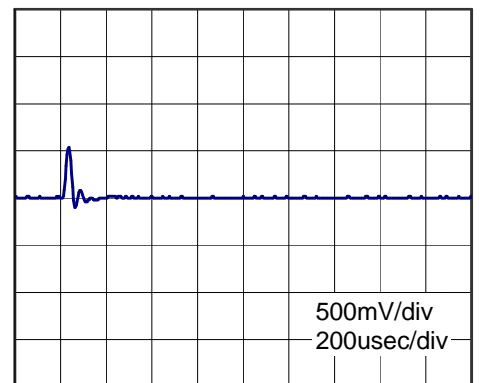
(c) Efficiency ( by Load Current )



(d) Power Dissipation( by Load Current )



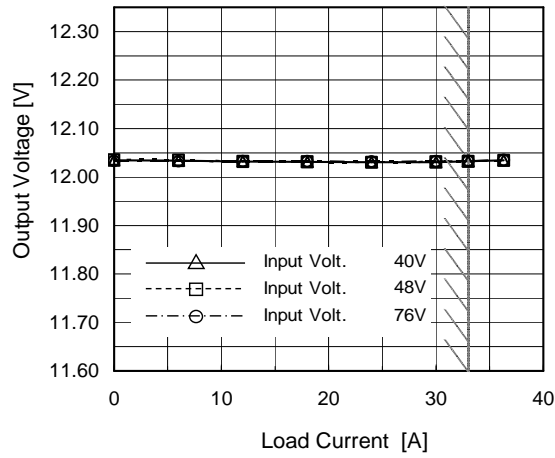
(e) Dynamic Load Response  
Load 50%(16.5A)→Load 100%(33A) / 50us  
Vin 48V, Vout 12V



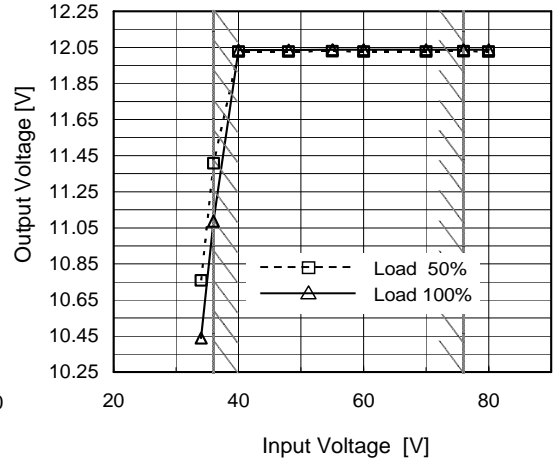
(f) Dynamic Load Response  
Load 100%(33A)→Load 50%(16.5A) / 50us  
Vin 48V, Vout 12V

### 5.7.9 CHS4004812H

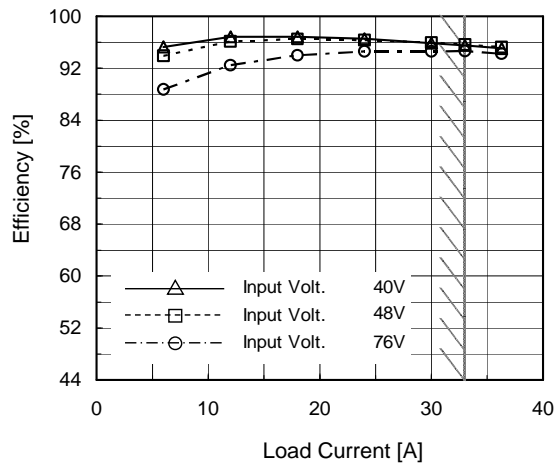
Fig.5.7.9  
Overview of  
CHS4004812H at 25°C



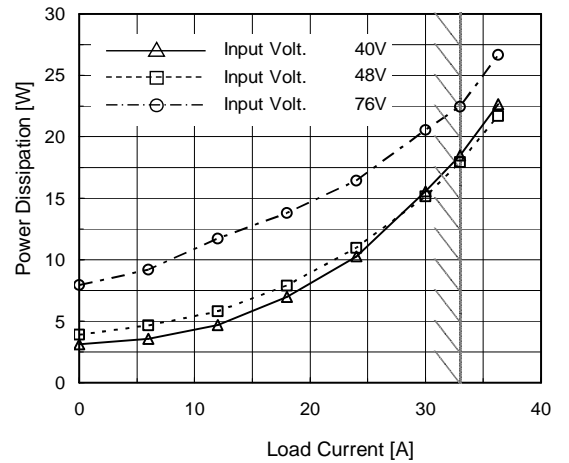
(a) Load Regulation



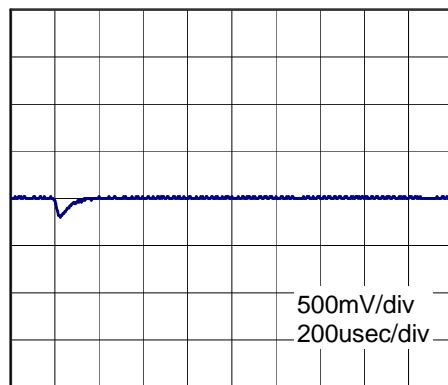
(b) Line Regulation



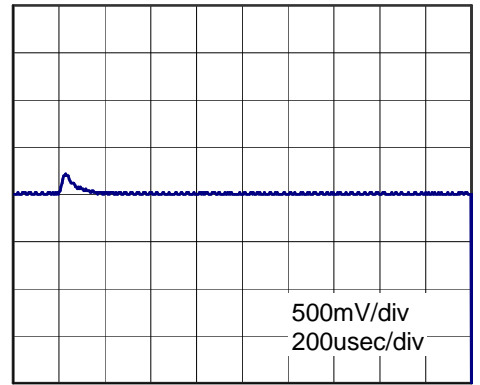
(c) Efficiency ( by Load Current )



(d) Power Dissipation( by Load Current )



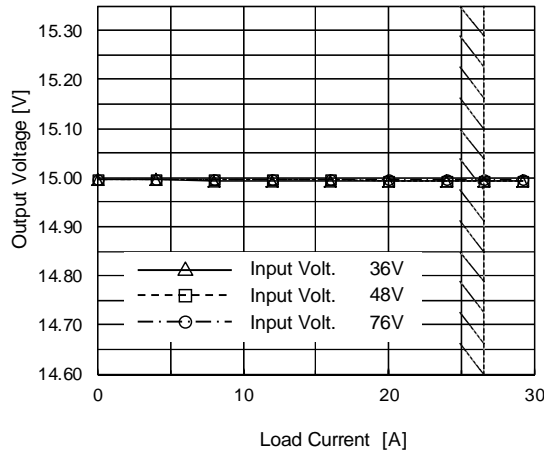
(e) Dynamic Load Response  
Load 50%(16.5A)→Load 100%(33A)/50us  
Vin 48V,Vout 12V



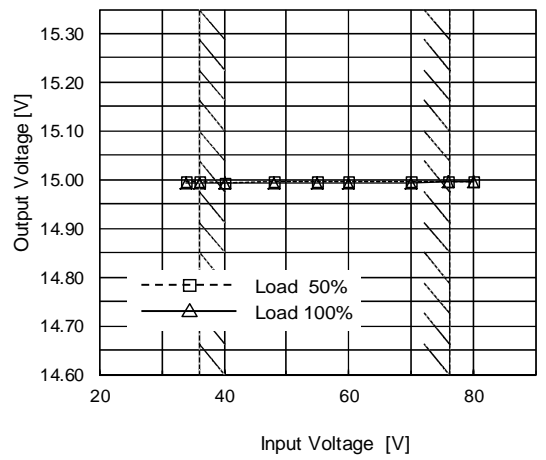
(f) Dynamic Load Response  
Load 100%(33A)→Load 50%(16.5A)/50us  
Vin 48V,Vout 12V

### 5.7.10 CHS4004815

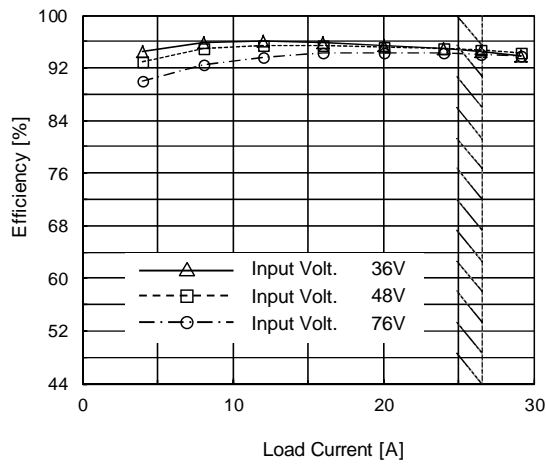
Fig.5.7.10  
Overview of  
CHS4004815 at 25°C



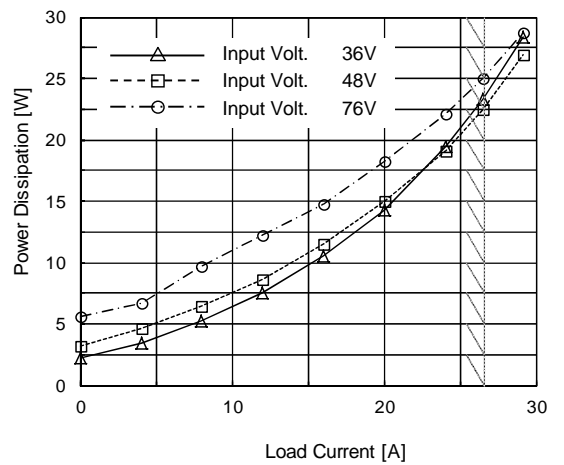
(a) Load Regulation



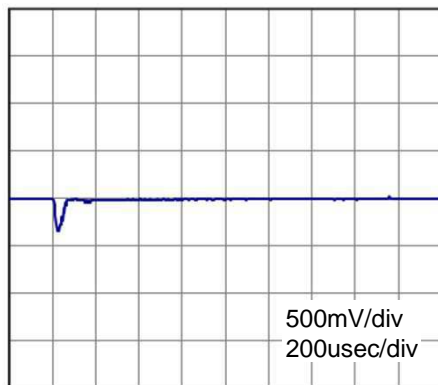
(b) Line Regulation



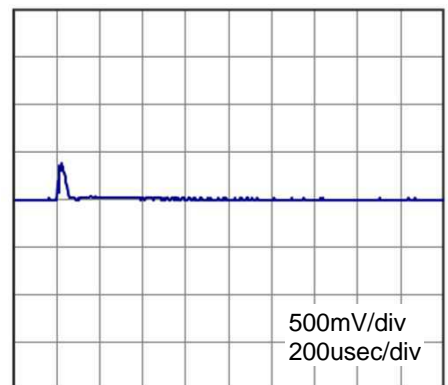
(c) Efficiency (by Load Current)



(d) Power Dissipation (by Load Current)



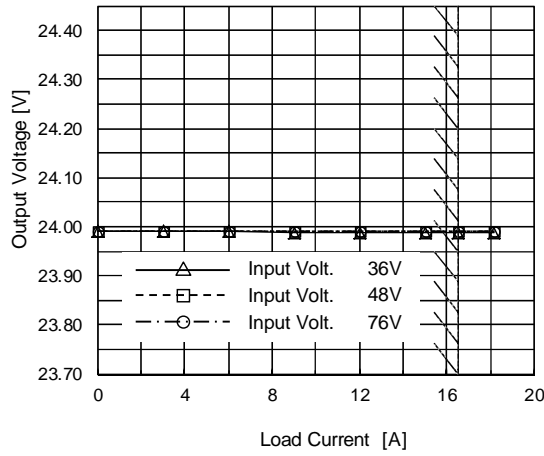
(e) Dynamic Load Response  
Load 50%(13.25A)→Load 100%(26.5A) / 50us  
Vin 48V, Vout 15V



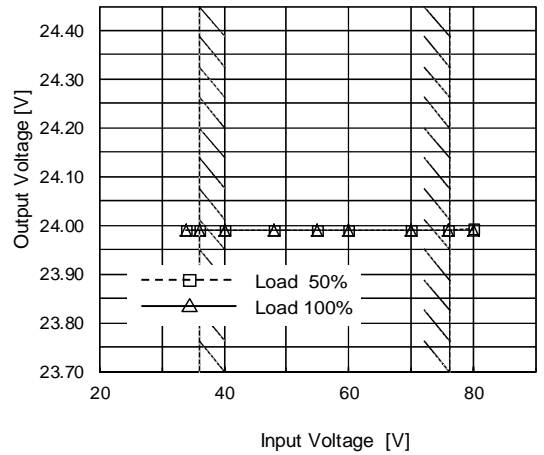
(f) Dynamic Load Response  
Load 100%(26.5A)→Load 50%(13.25A) / 50us  
Vin 48V, Vout 15V

### 5.7.11 CHS4004824

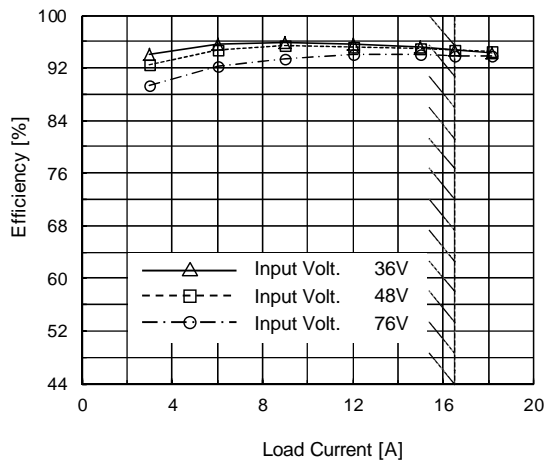
Fig.5.7.11  
Overview of  
CHS4004824 at 25°C



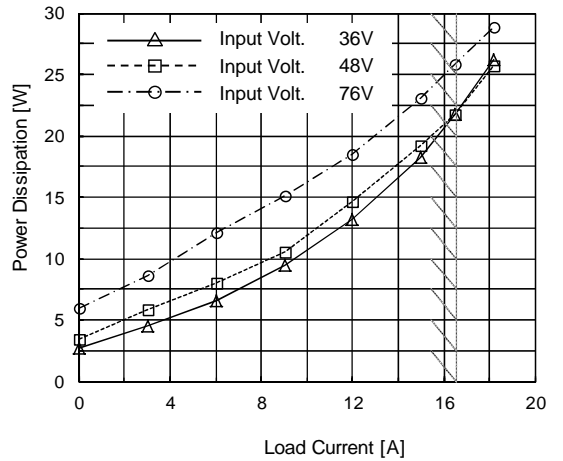
(a) Load Regulation



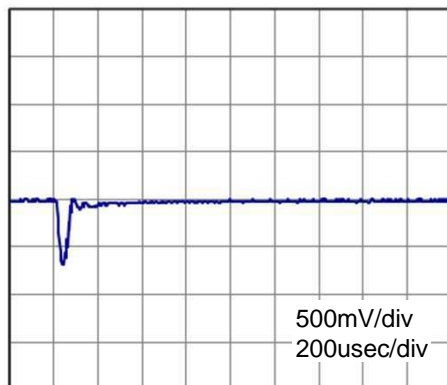
(b) Line Regulation



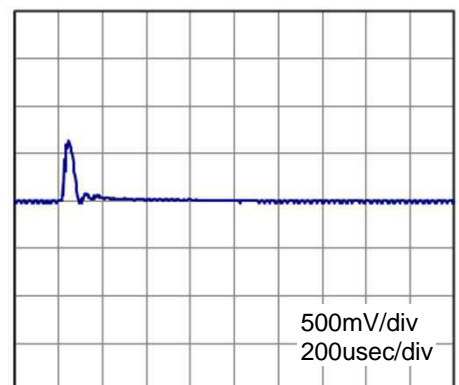
(c) Efficiency ( by Load Current )



(d) Power Dissipation( by Load Current )



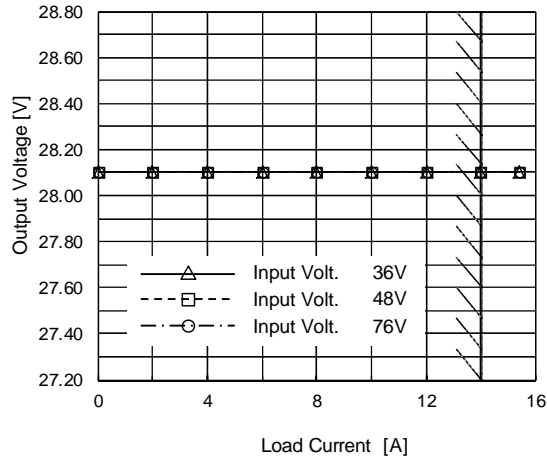
(e) Dynamic Load Response  
Load 50%(8.25A)→Load 100%(16.5A)/50us  
Vin 48V,Vout 24V



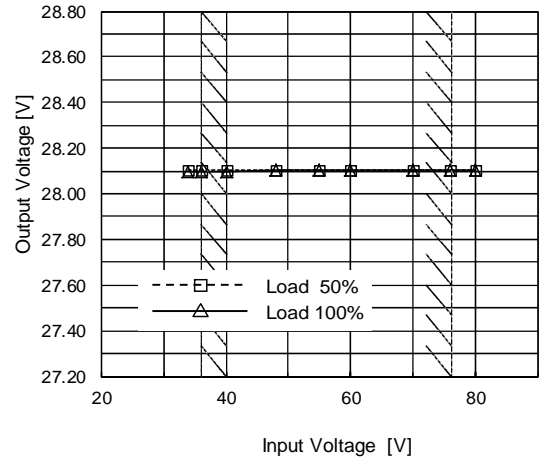
(f) Dynamic Load Response  
Load 100%(16.5A)→Load 50%(8.25A)/50us  
Vin 48V,Vout 24V

### 5.7.12 CHS4004828

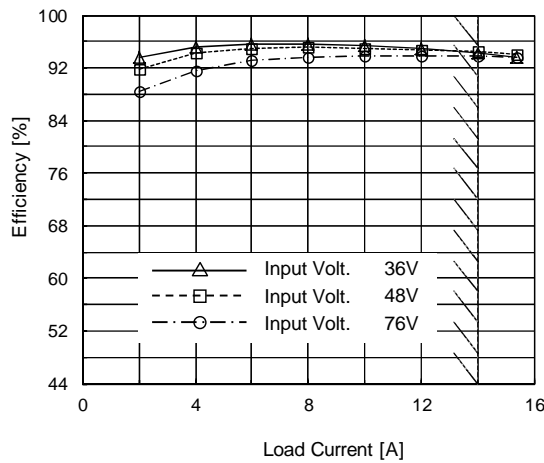
Fig.5.7.12  
Overview of  
CHS4004828 at 25°C



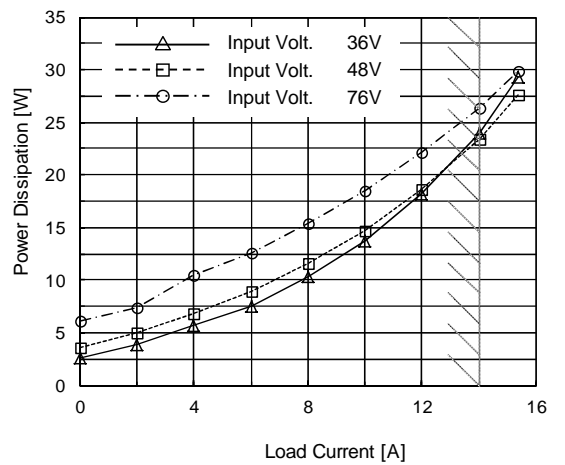
(a) Load Regulation



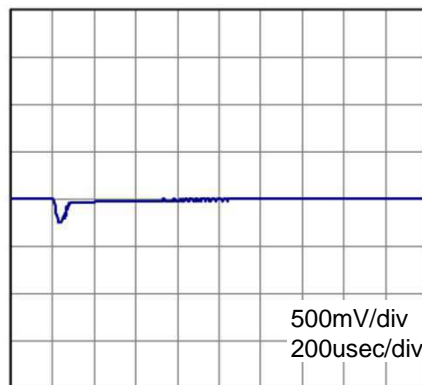
(b) Line Regulation



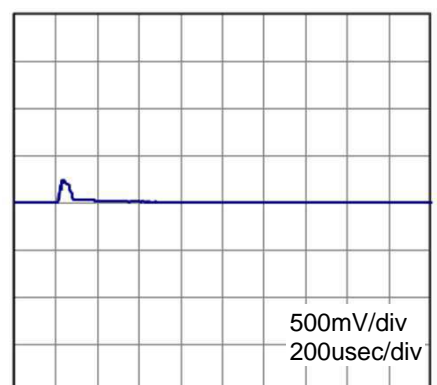
(c) Efficiency ( by Load Current )



(d) Power Dissipation( by Load Current )



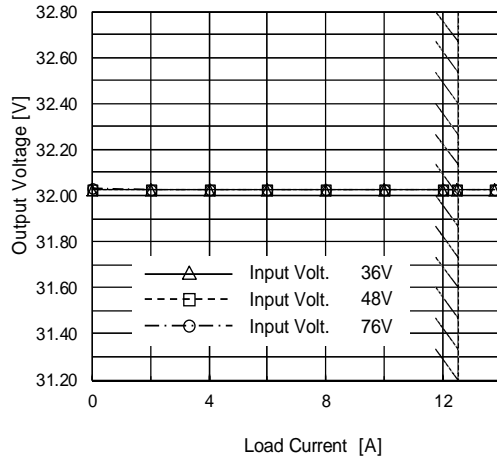
(e) Dynamic Load Response  
Load 50%(7A)→Load 100%(14A)/50us  
Vin 48V, Vout 28V



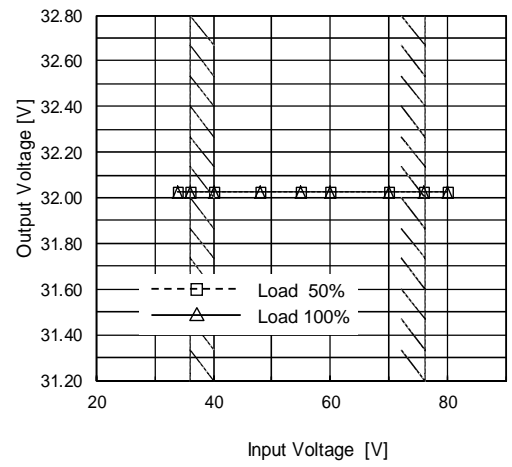
(f) Dynamic Load Response  
Load 100%(14A)→Load 50%(7A)/50us  
Vin 48V, Vout 28V

### 5.7.13 CHS4004832

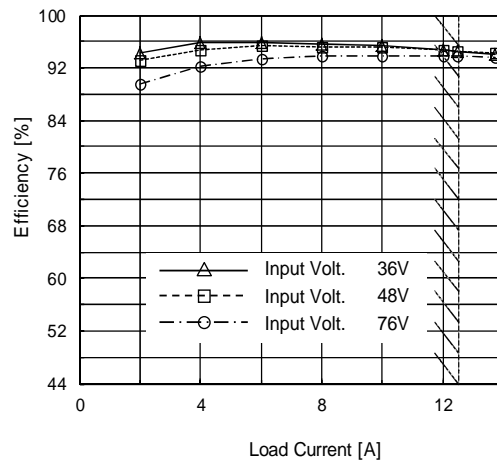
Fig.5.7.13  
Overview of  
CHS4004832 at 25°C



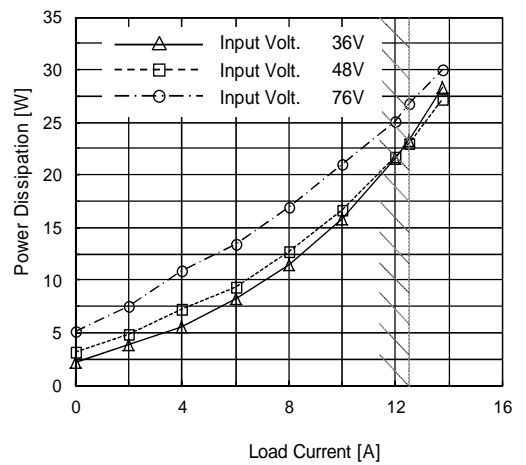
(a) Load Regulation



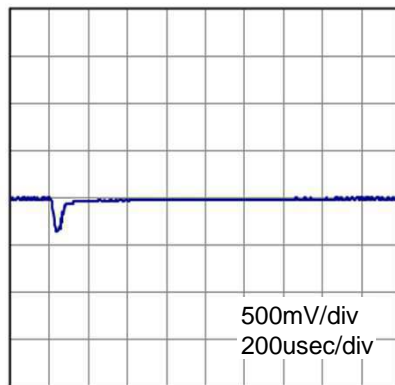
(b) Line Regulation



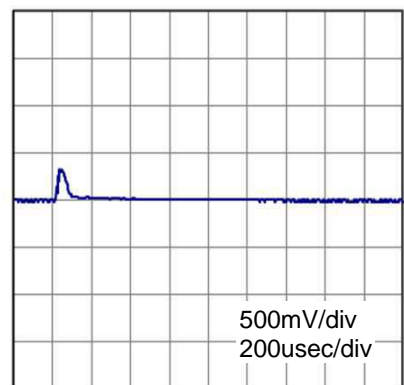
(c) Efficiency ( by Load Current )



(d) Power Dissipation( by Load Current )



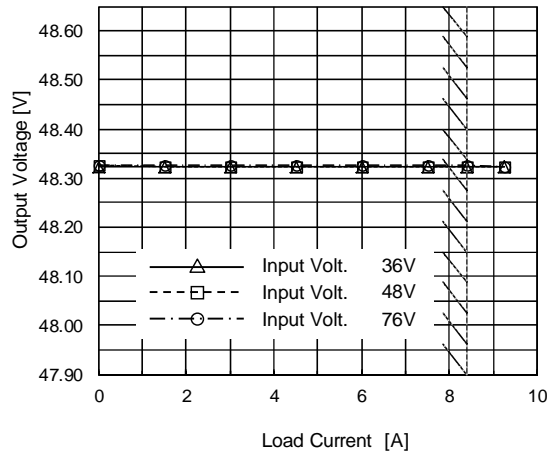
(e) Dynamic Load Response  
Load 50%(6.25A)→Load 100%(12.5A)/50us  
Vin 48V, Vout 32V



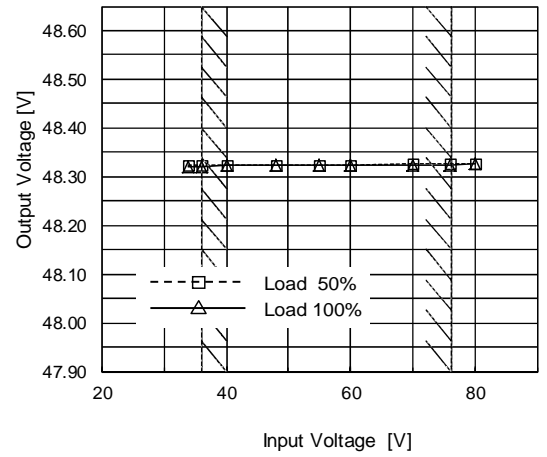
(f) Dynamic Load Response  
Load 100%(12.5A)→Load 50%(6.25A)/50us  
Vin 48V, Vout 32V

### 5.7.14 CHS4004848

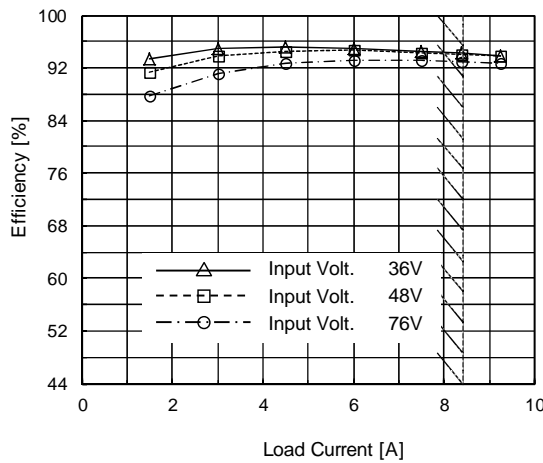
Fig.5.7.14  
Overview of  
CHS4004848 at 25°C



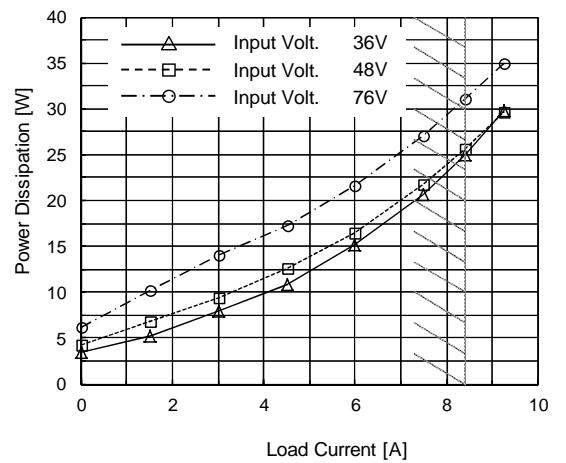
(a) Load Regulation



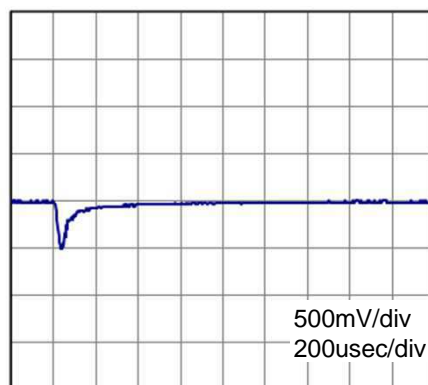
(b) Line Regulation



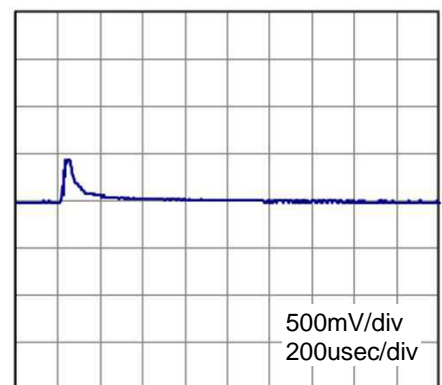
(c) Efficiency ( by Load Current )



(d) Power Dissipation( by Load Current )



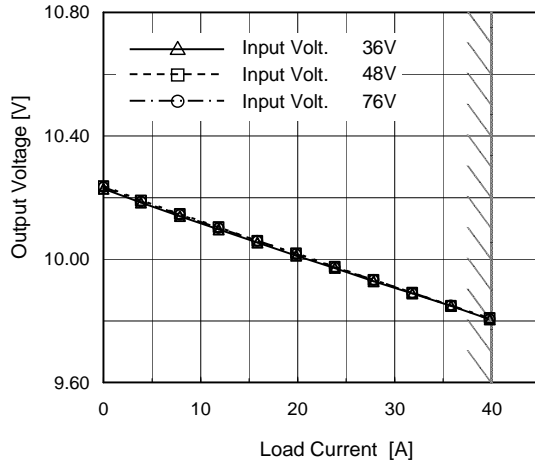
(e) Dynamic Load Response  
Load 50%(4.2A)→Load 100%(8.4A)/50us  
Vin 48V, Vout 48V



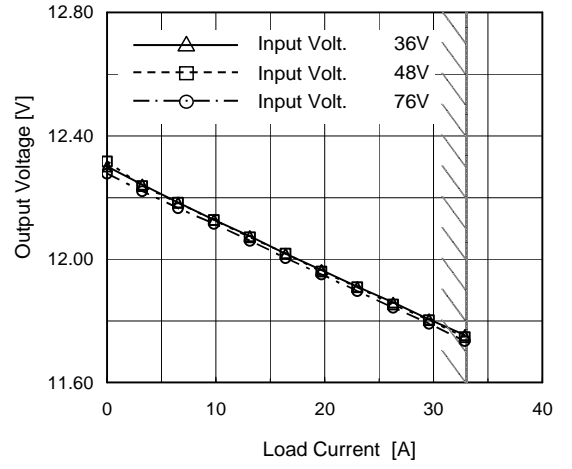
(f) Dynamic Load Response  
Load 100%(8.4A)→Load 50%(4.2A)/50us  
Vin 48V, Vout 48V

● CHS40048□□-P (Option "-P") Load Regulation

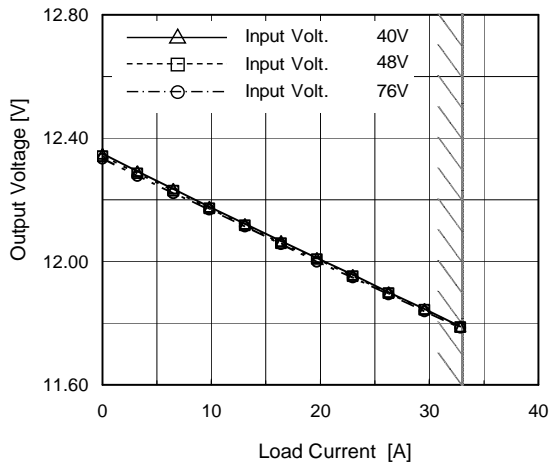
Fig.5.7.15  
Load Regulation of  
Option "-P"



(a) CHS4004810-P



(b) CHS4004812-P



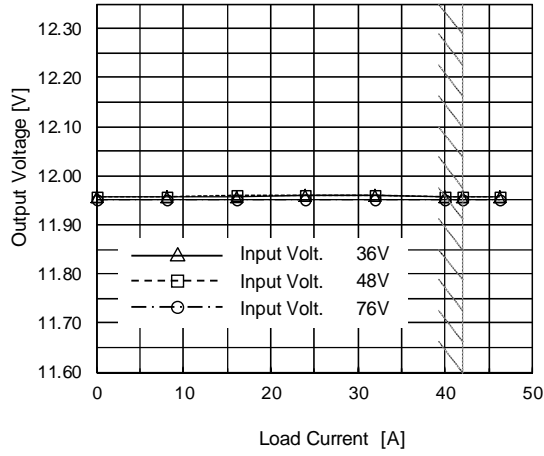
(c) CHS4004812H-P



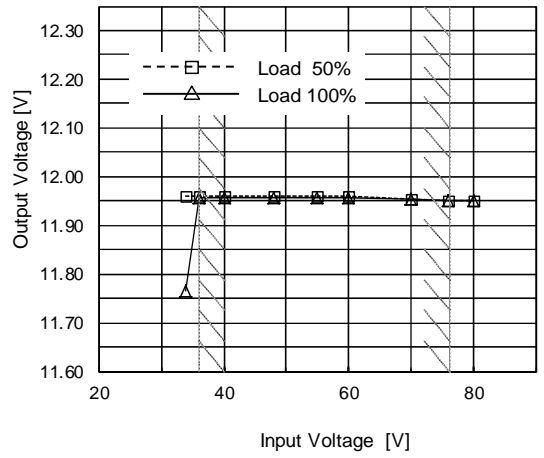
5.8 CHS500

5.8.1 CHS5004812

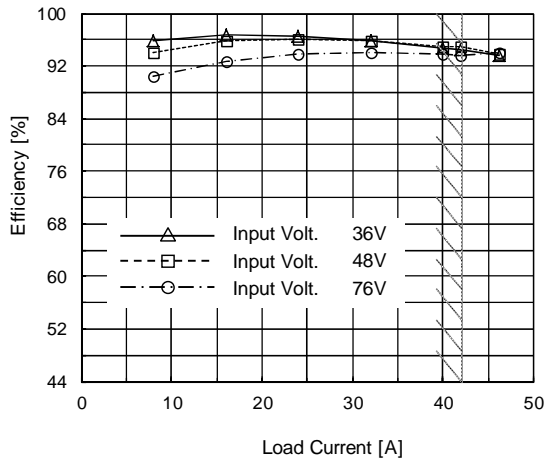
Fig.5.8.1  
Overview of  
CHS5004812 at 25°C



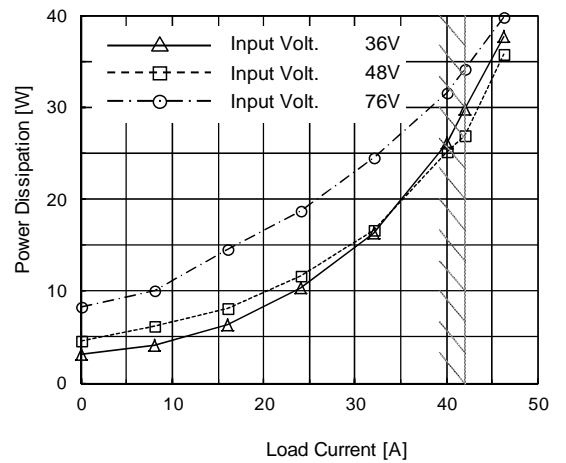
(a) Load Regulation



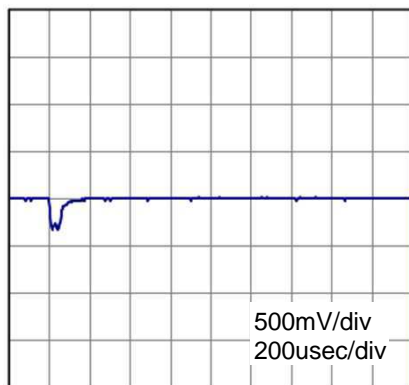
(b) Line Regulation



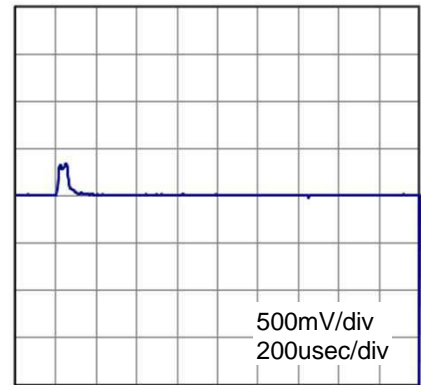
(c) Efficiency (by Load Current)



(d) Power Dissipation (by Load Current)



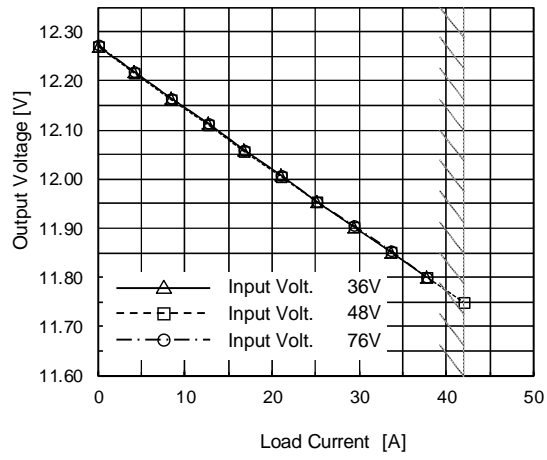
(e) Dynamic Load Response  
Load 50%(21A)→Load 100%(42A) / 50us  
Vin 48V, Vout 12V



(f) Dynamic Load Response  
Load 100%(42A)→Load 50%(21A) / 50us  
Vin 48V, Vout 12V

● CHS5004812-P (Option "-P") Load Regulation

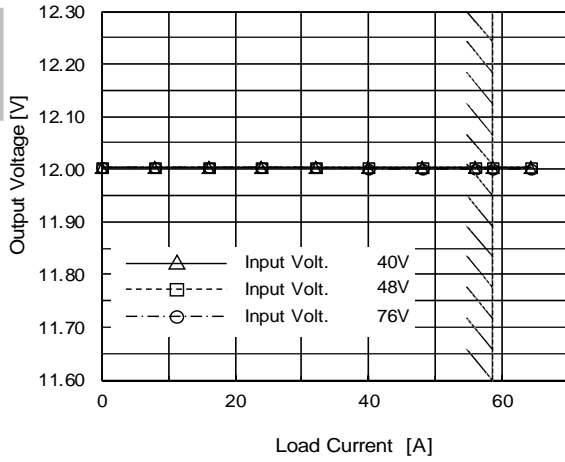
Fig.5.8.2  
Load Regulation of  
Option "-P"



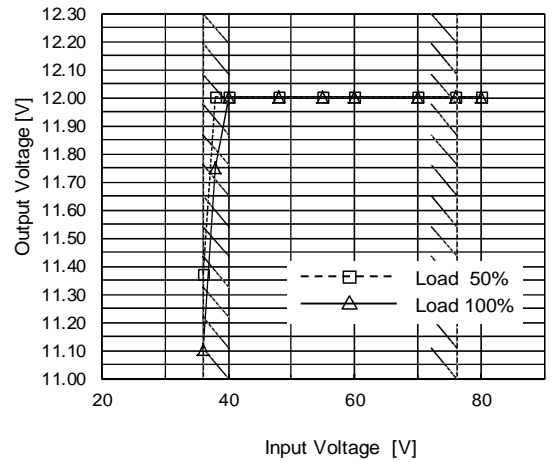
5.9 CHS700

5.9.1 CHS7004812H

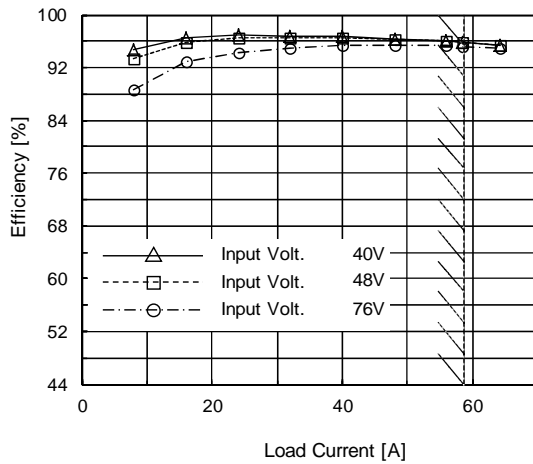
Fig.5.9.1  
Overview of  
CHS7004812H at 25°C



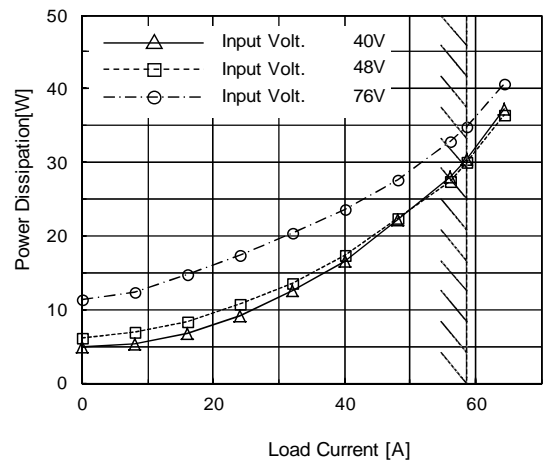
(a) Load Regulation



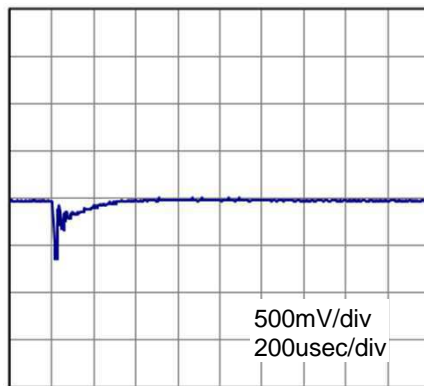
(b) Line Regulation



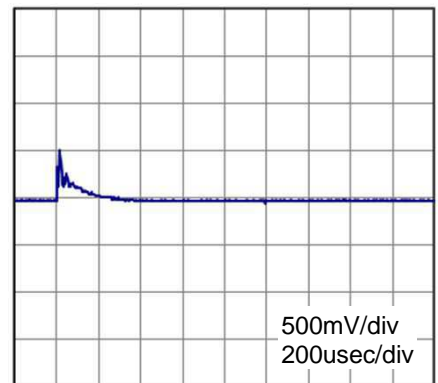
(c) Efficiency (by Load Current)



(d) Power Dissipation (by Load Current)



(e) Dynamic Load Response  
Load 50%(29.25A)→Load 100%(58.5A)/50us  
Vin 48V, Vout 12V



(f) Dynamic Load Response  
Load 100%(58.5A)→Load 50%(29.25A)/50us  
Vin 48V, Vout 12V

## 5.10 Derating

- Use with the convection cooling or the forced air cooling.

Make sure the temperatures at temperature measurement locations shown from Fig5.10.17~ Fig5.10.27 below are on or under the derating curve in Fig5.10.1~Fig5.10.16.

Ambient temperature must be kept at 85°C or under.

Fig.5.10.1  
Derating curve  
for CHS60,  
CHS80, CHS200

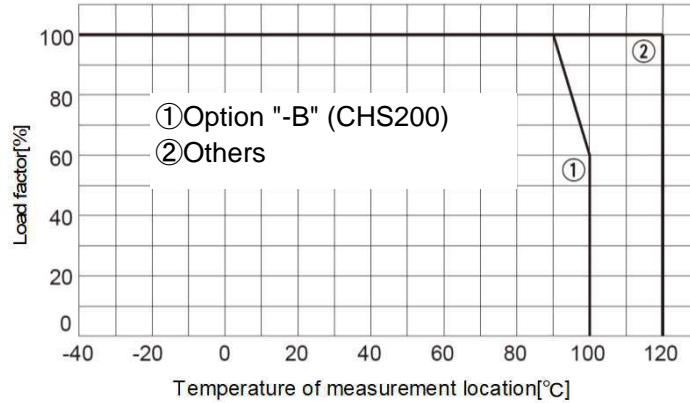


Fig.5.10.2  
Derating curve  
for CHS12024

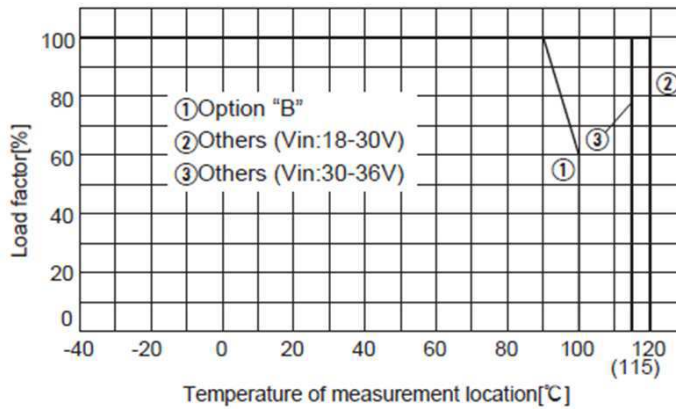


Fig.5.10.3  
Derating curve  
for CHS12024-BC

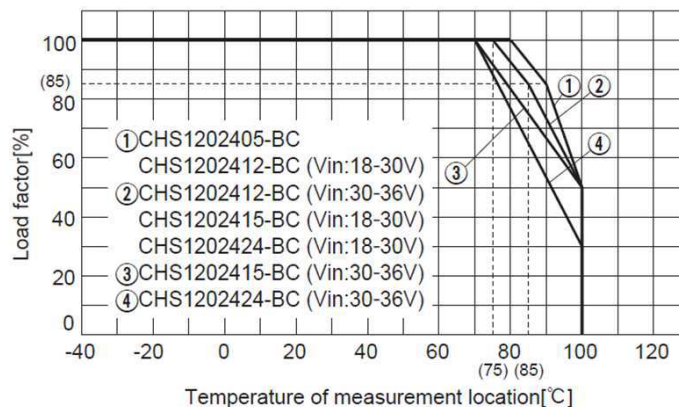


Fig.5.10.4  
Derating curve  
for CHS12048

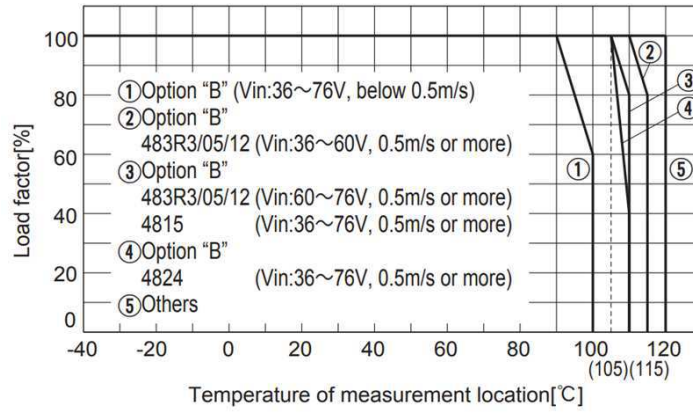


Fig.5.10.5  
Derating curve  
for CHS30024

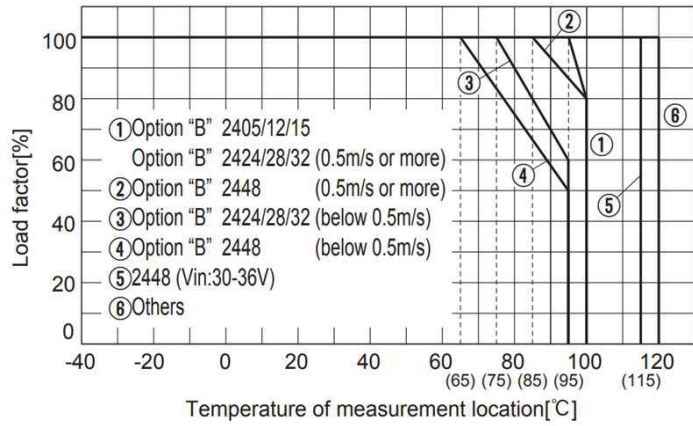


Fig.5.10.6  
Derating curve  
for CHS30024-BC

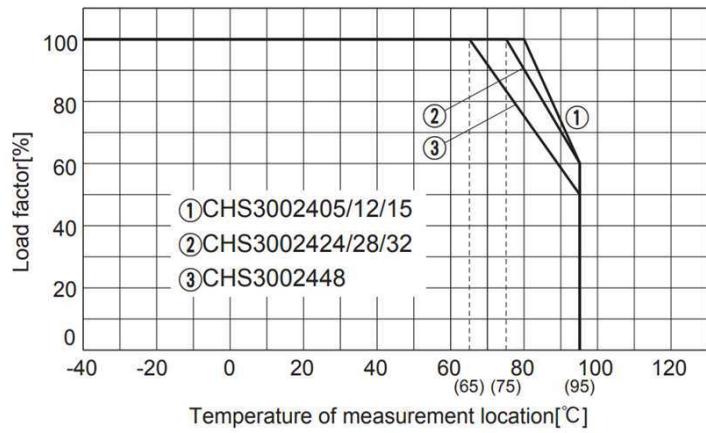


Fig.5.10.7  
Derating curve  
for CHS30048

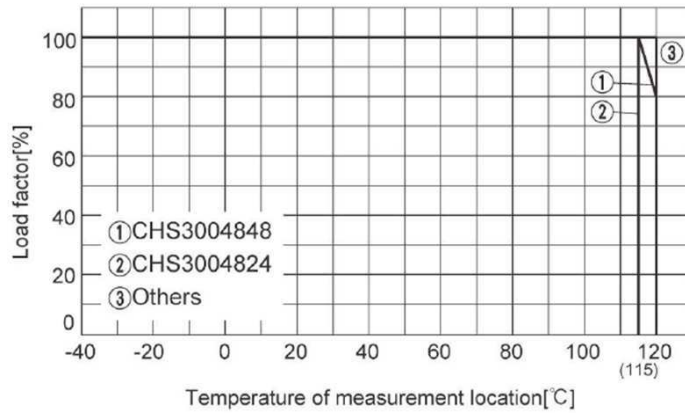


Fig.5.10.8  
Derating curve  
for CHS30048-B

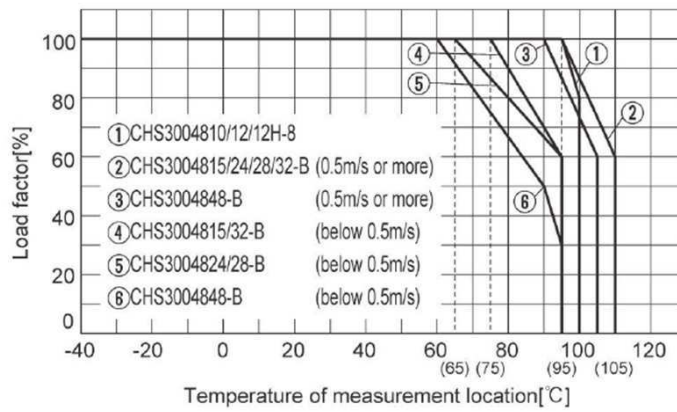


Fig.5.10.9  
Derating curve  
for CHS3804812,  
CHS3804812H

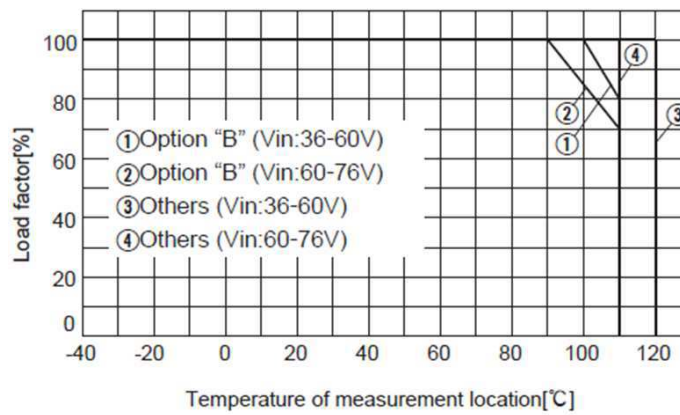


Fig.5.10.10  
Derating curve  
for CHS3804810

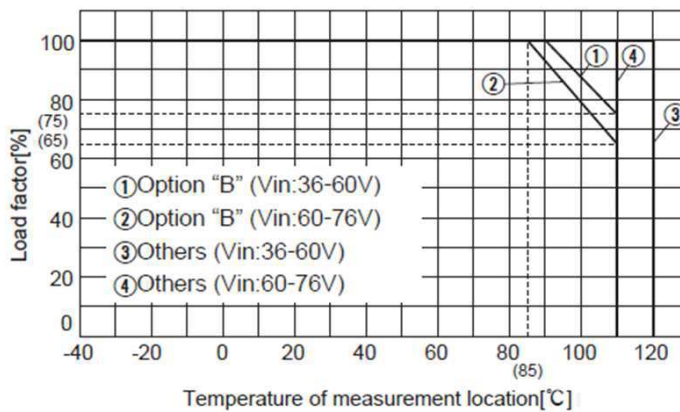


Fig.5.10.11  
Derating curve  
for CHS40024

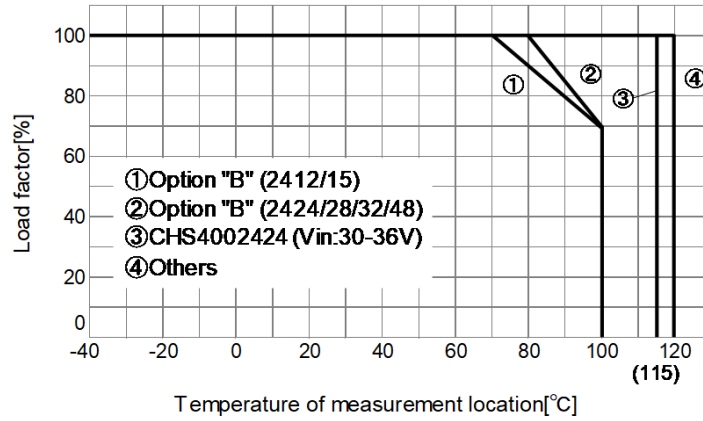


Fig.5.10.12  
Derating curve  
for CHS4002412/15-BC

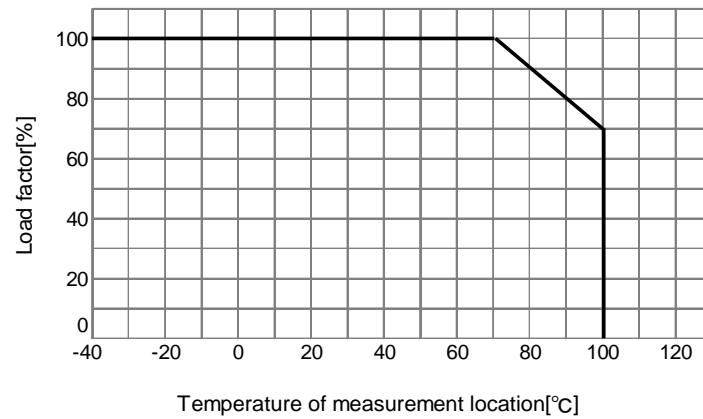


Fig.5.10.13  
Derating curve  
for CHS4002424/28-BC,  
CHS4002432/48-BC

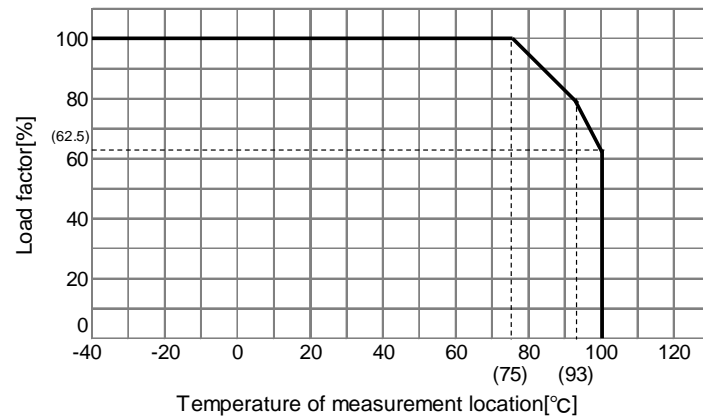


Fig.5.10.14  
Derating curve  
for CHS40048

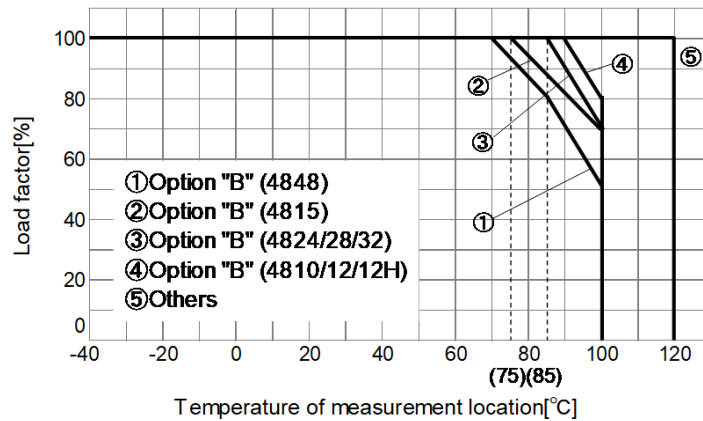


Fig.5.10.15  
Derating curve  
for CHS500,CHS500-B

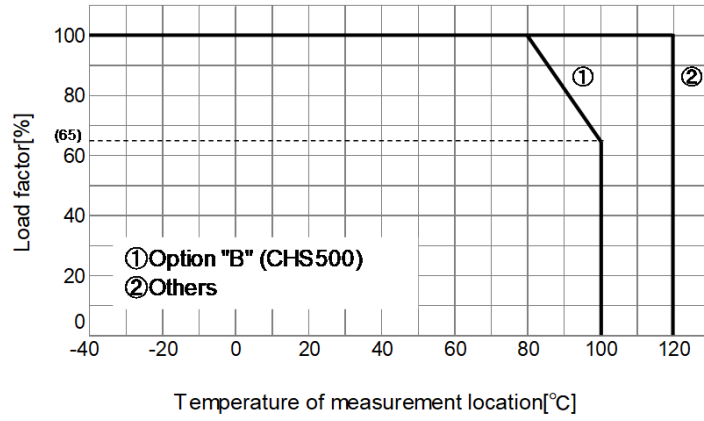


Fig.5.10.16  
Derating curve  
for CHS70048

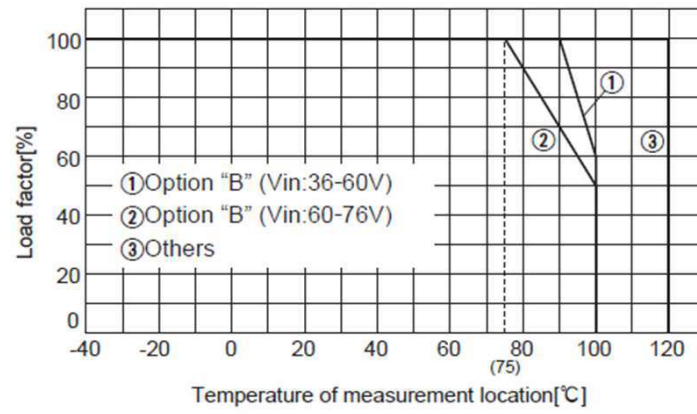
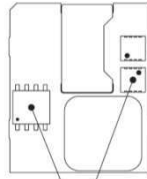


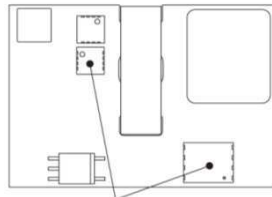


Fig.5.10.17  
Temperature  
measurement  
location for CHS60



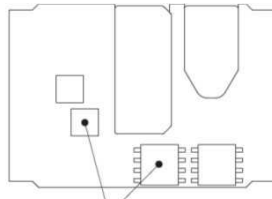
Temperature measurement location

Fig.5.10.18  
Temperature  
measurement  
location for CHS80



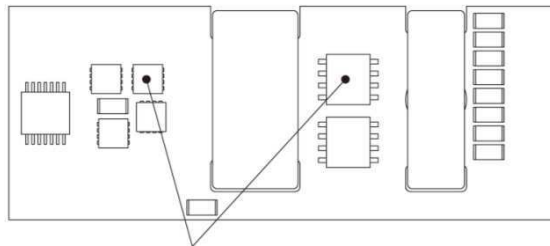
Temperature measurement location

Fig.5.10.19  
Temperature  
measurement  
location for CHS120



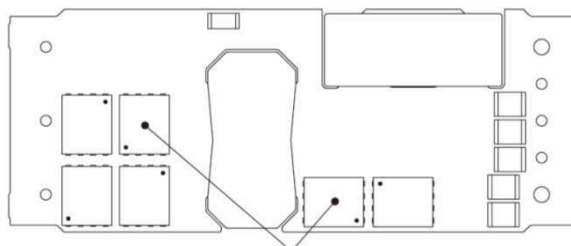
Temperature measurement location

Fig.5.10.20  
Temperature  
measurement  
location for CHS200



Temperature measurement location

Fig.5.10.21  
Temperature  
measurement  
location for CHS3002405,  
CHS3002412/15,  
CHS3004810/12/12H



Temperature measurement location

Fig.5.10.22  
Temperature  
measurement  
location for CHS3002424,  
CHS3002428/32/48,  
CHS3004815/24/28/32/48

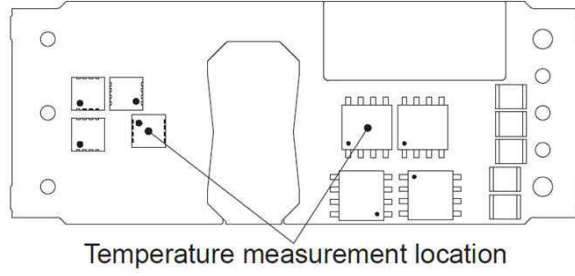


Fig.5.10.23  
Temperature  
measurement  
location for CHS380

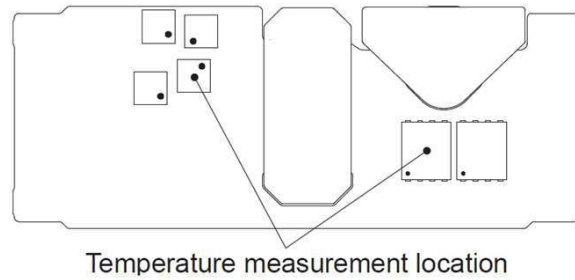


Fig.5.10.24  
Temperature  
measurement  
location for CHS40024,  
CHS4004815/24/28/32/48

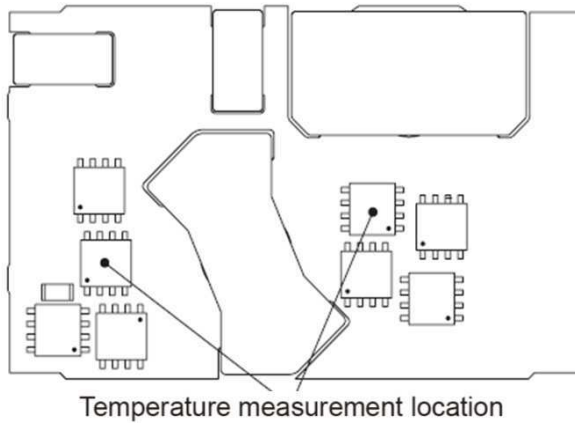


Fig.5.10.25  
Temperature  
measurement  
location for CHS4004810,  
CHS4004812/12H

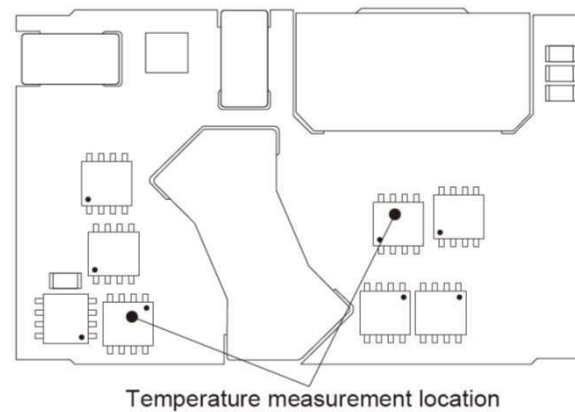


Fig.5.10.26  
Temperature  
measurement  
location for CHS500

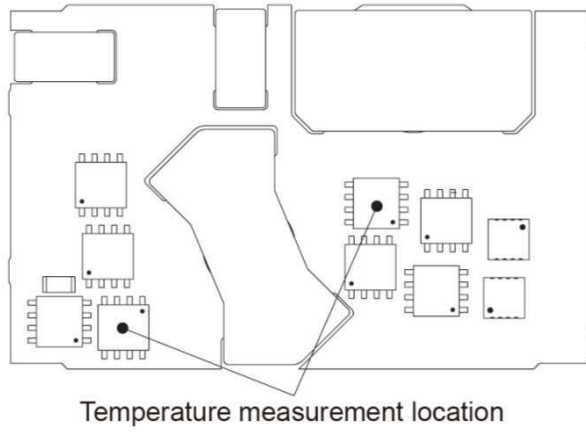
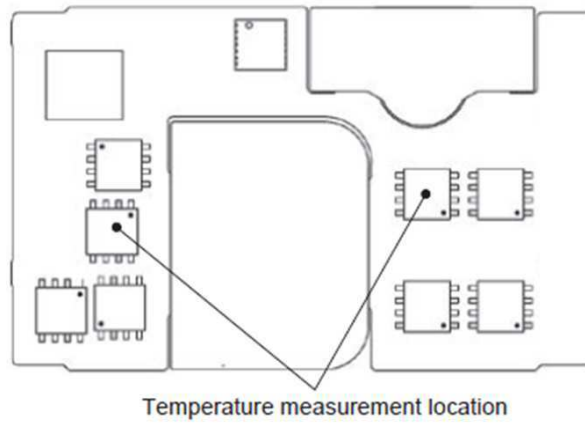


Fig.5.10.27  
Temperature  
measurement  
location for CHS700



- For option “-B” which is used with the convection cooling, forced air cooling or conduction cooling, use the temperature measurement location as shown in Fig.5.10.28 ~ Fig.5.10.30.

Fig.5.10.28  
Measurement location  
(CHS120  
option "-B" and "-BC")

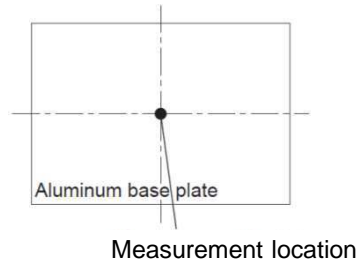


Fig.5.10.29  
Measurement location  
(CHS200/CHS300/CHS380  
option "-B" and "-BC")

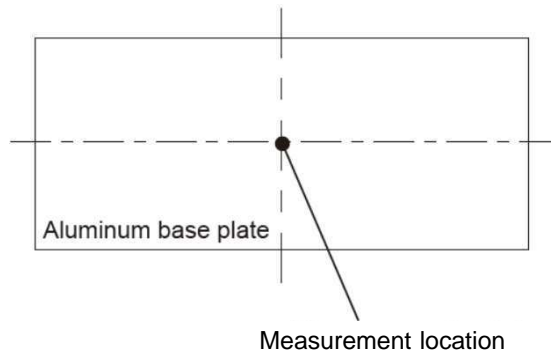
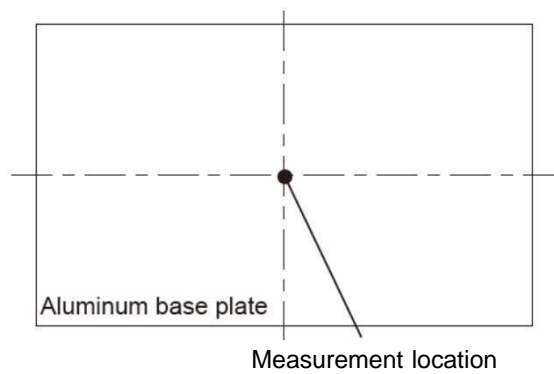


Fig.5.10.30  
Measurement location  
(CHS400/CHS500/CHS700  
option "-B" and "-BC")



- Fig.5.10.32 ~ 5.10.83 show the derating curve in the condition that is measured as shown in Fig.5.10.31.  
Verify final design by actual temperature measurement.  
Make sure the temperatures at temperature measurement locations shown from Fig.5.10.17 to Fig.5.10.27.  
It should not exceed the derating curve in Fig.5.10.1 to Fig.5.10.16.

Fig.5.10.31  
Measuring method

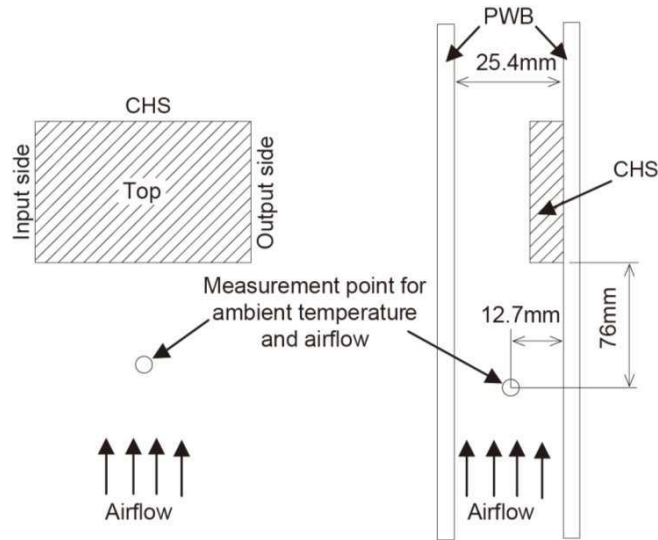


Fig.5.10.32  
Derating curve  
for CHS60483R3  
Vin=48V

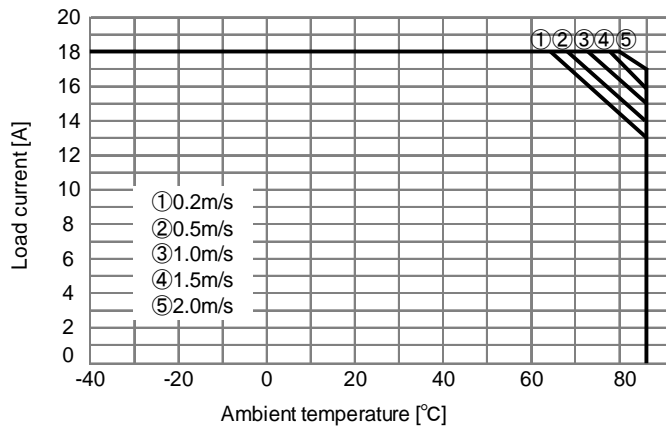


Fig.5.10.33  
Derating curve  
for CHS604805  
Vin=48V

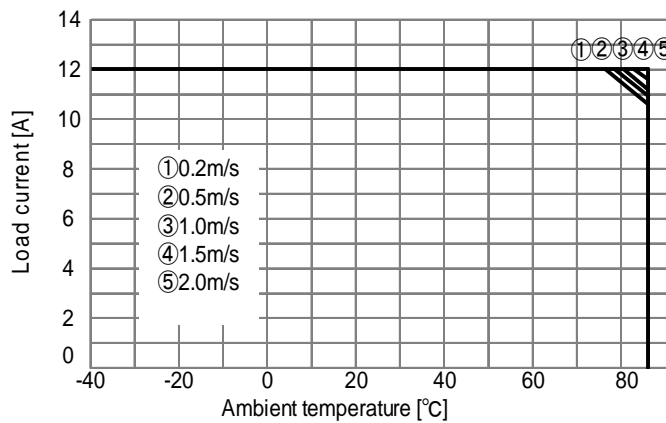


Fig.5.10.34  
Derating curve  
for CHS604812  
Vin=48V

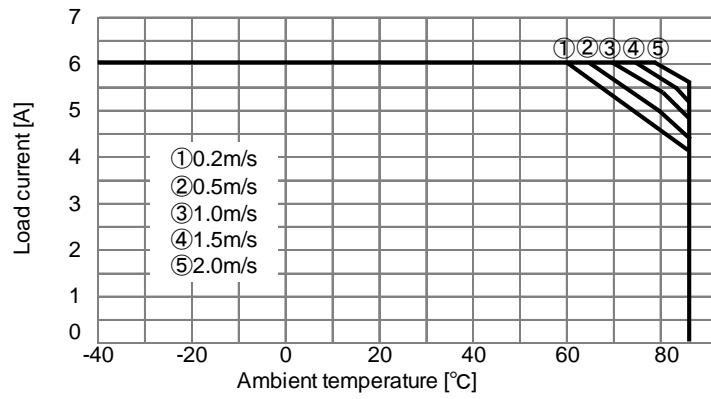


Fig.5.10.35  
Derating curve  
for CHS80483R3  
Vin=48V

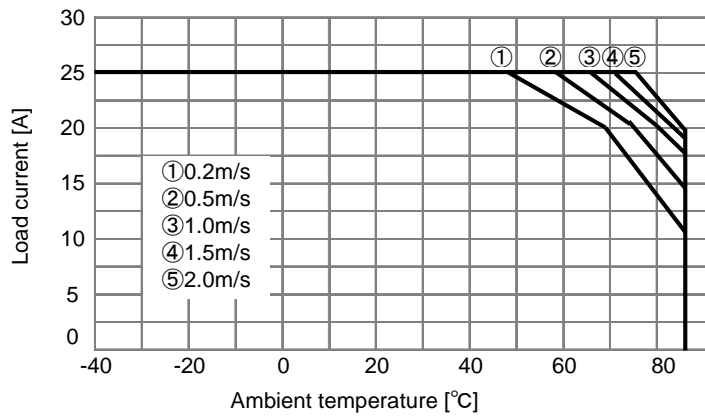


Fig.5.10.36  
Derating curve  
for CHS804805  
Vin=48V

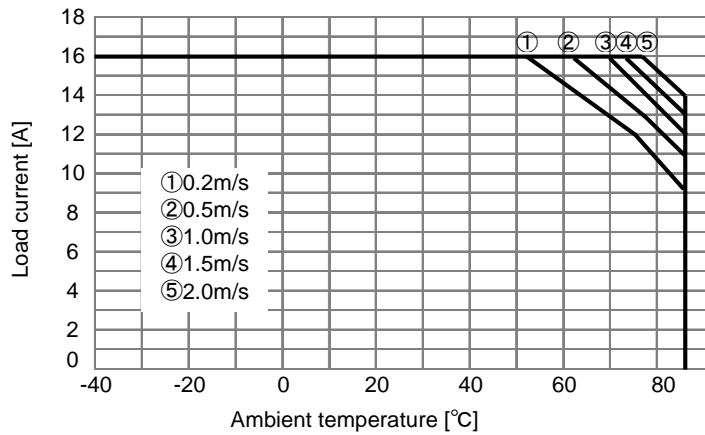


Fig.5.10.37  
Derating curve  
for CHS804812  
Vin=48V

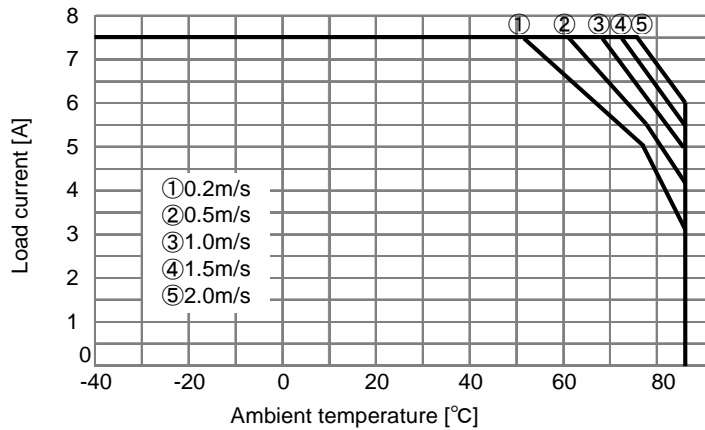


Fig.5.10.38  
Derating curve  
for CHS1202405  
Vin=24V

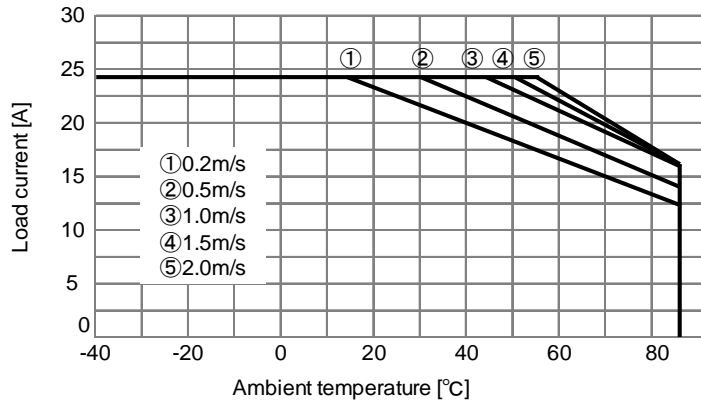


Fig.5.10.39  
Derating curve  
for CHS1202412  
Vin=24V

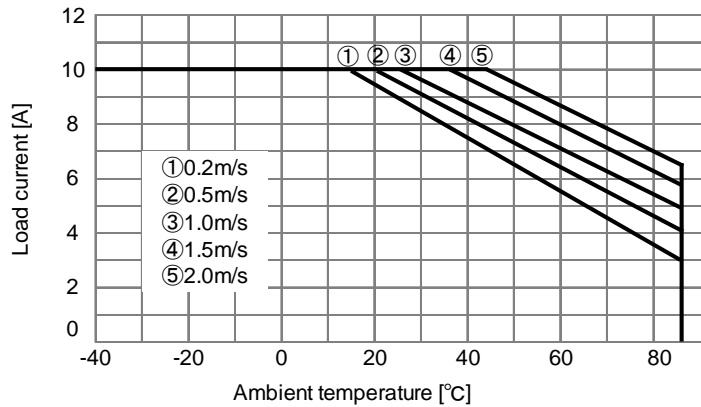


Fig.5.10.40  
Derating curve  
for CHS1202415  
Vin=24V

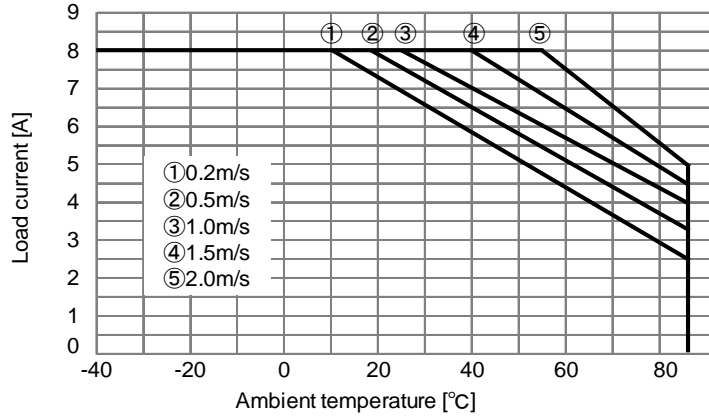


Fig.5.10.41  
Derating curve  
for CHS1202424  
Vin=24V

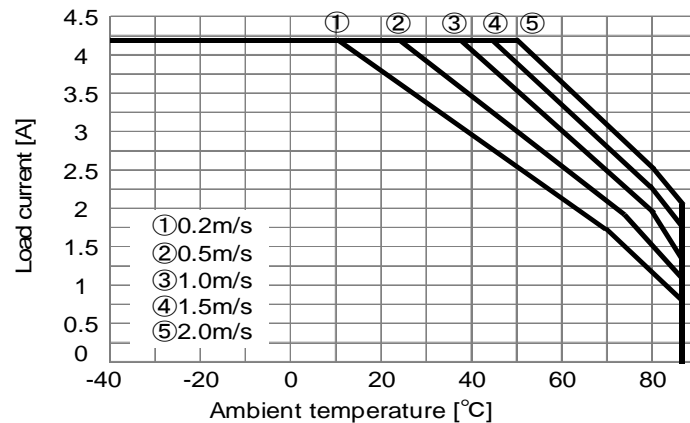


Fig.5.10.42  
Derating curve  
for CHS120483R3  
Vin=48V

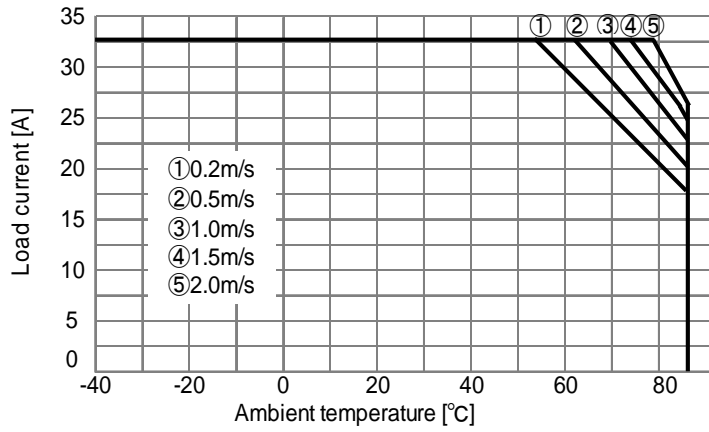


Fig.5.10.43  
Derating curve  
for CHS1204805  
Vin=48V

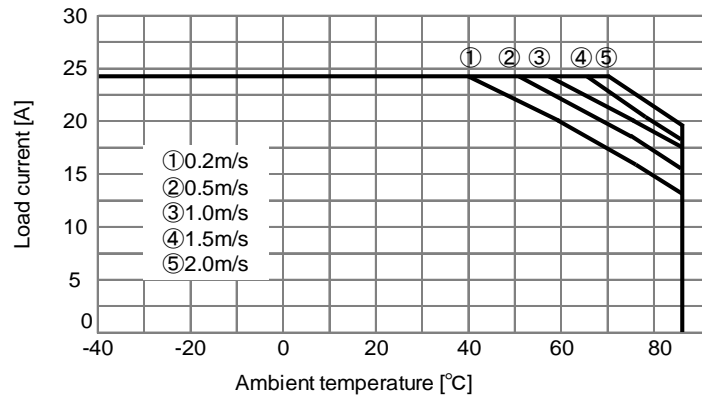


Fig.5.10.44  
Derating curve  
for CHS1204812  
Vin=48V

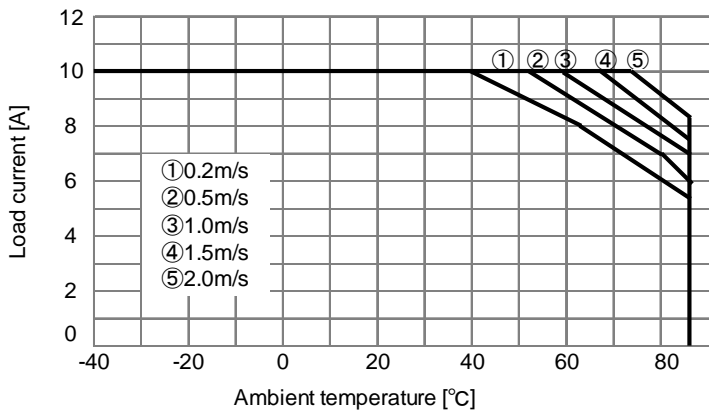


Fig.5.10.45  
Derating curve  
for CHS1204815  
Vin=48V

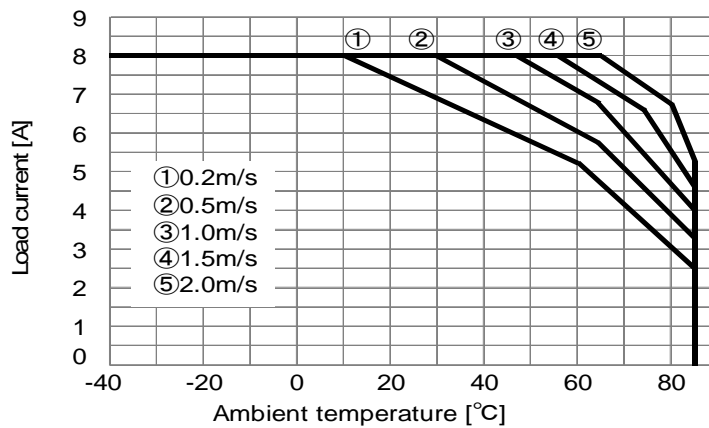




Fig.5.10.46  
Derating curve  
for CHS1204824  
 $V_{in}=48V$

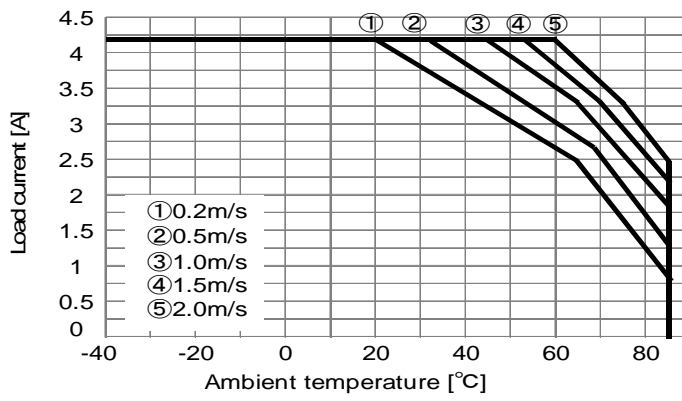


Fig.5.10.47  
Derating curve  
for CHS200483R3  
 $V_{in}=48V$

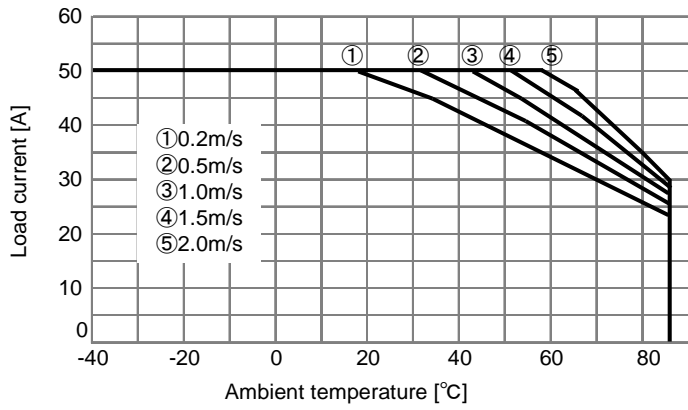


Fig.5.10.48  
Derating curve  
for CHS2004805  
 $V_{in}=48V$

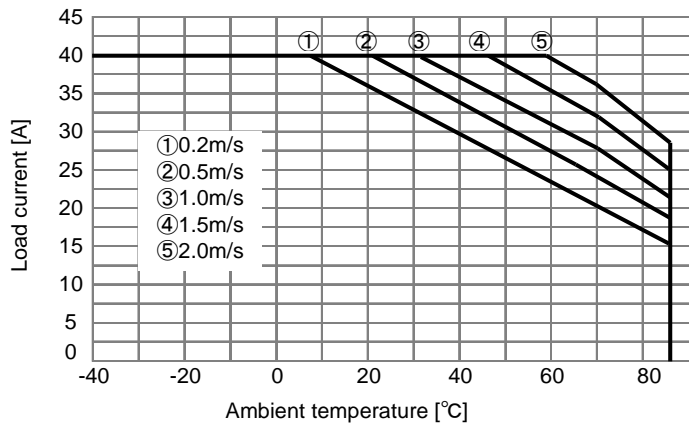


Fig.5.10.49  
Derating curve  
for CHS2004812  
 $V_{in}=48V$

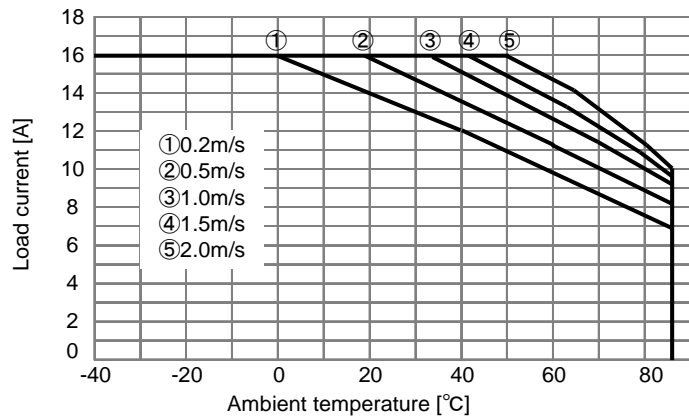


Fig.5.10.50  
Derating curve  
for CHS3002405  
Vin=24V

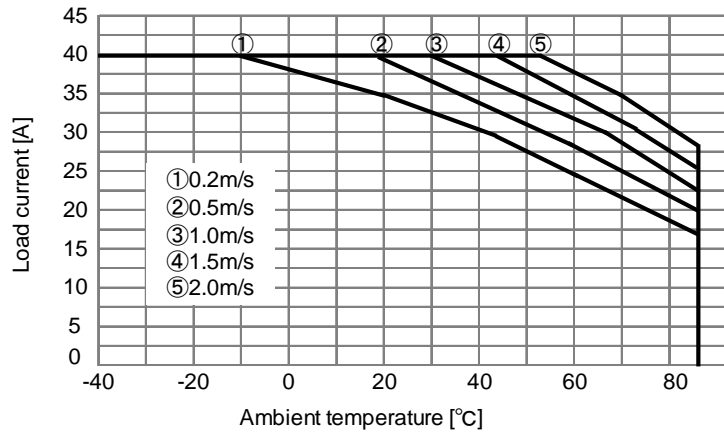


Fig.5.10.51  
Derating curve  
for CHS3002412  
Vin=24V

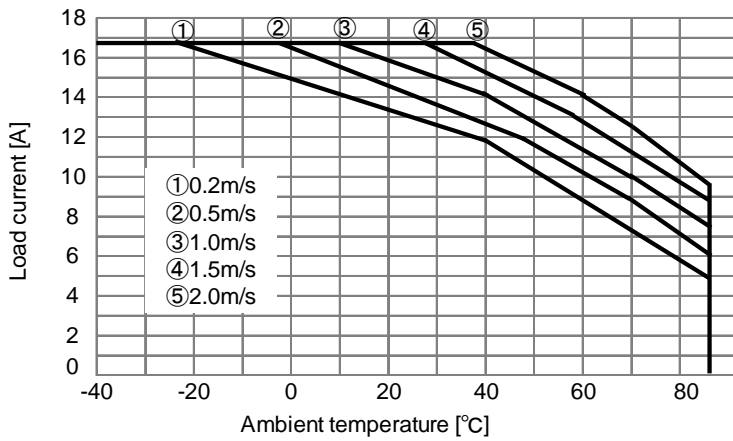


Fig.5.10.52  
Derating curve  
for CHS3002415  
Vin=24V

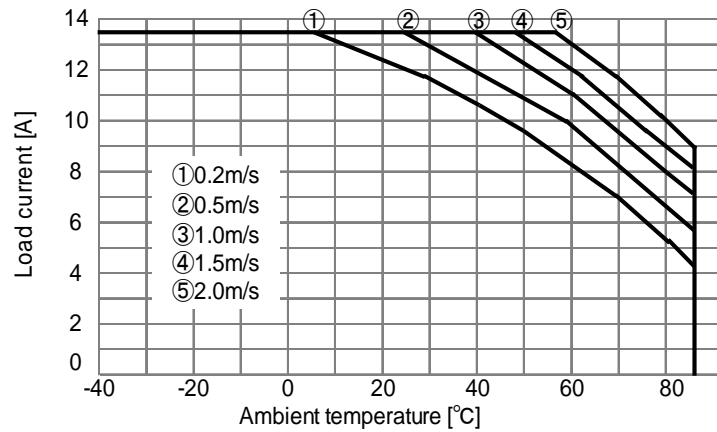


Fig.5.10.53  
Derating curve  
for CHS3002424  
Vin=24V

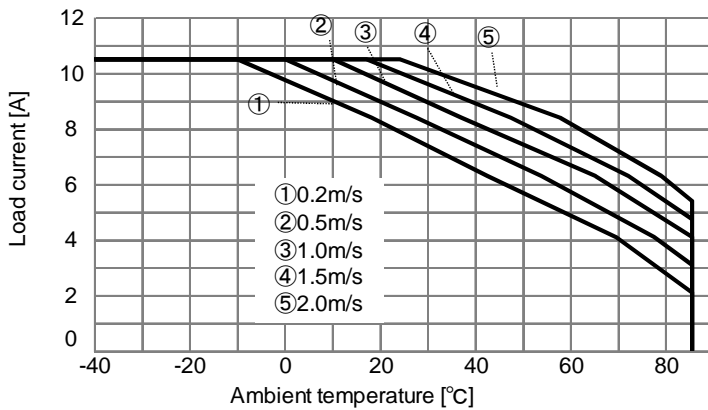


Fig.5.10.54  
Derating curve  
for CHS3002428  
Vin=24V

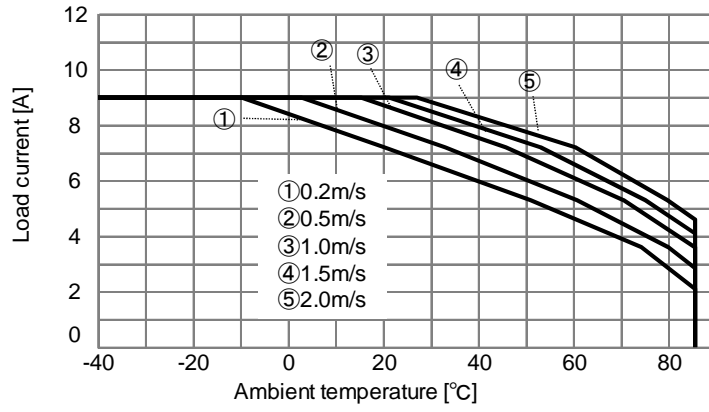


Fig.5.10.55  
Derating curve  
for CHS3002432  
Vin=24V

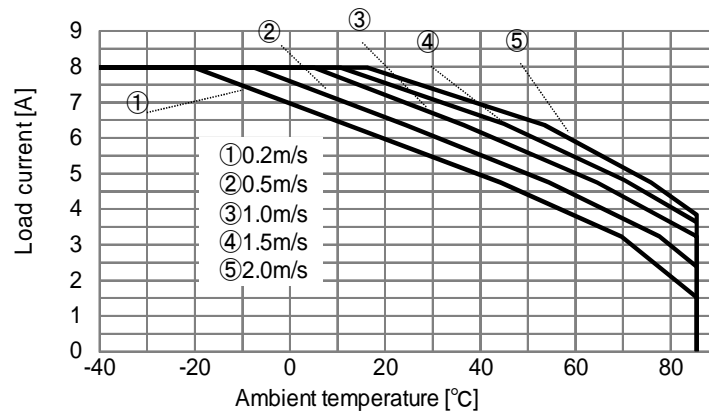


Fig.5.10.56  
Derating curve  
for CHS3002448  
Vin=24V

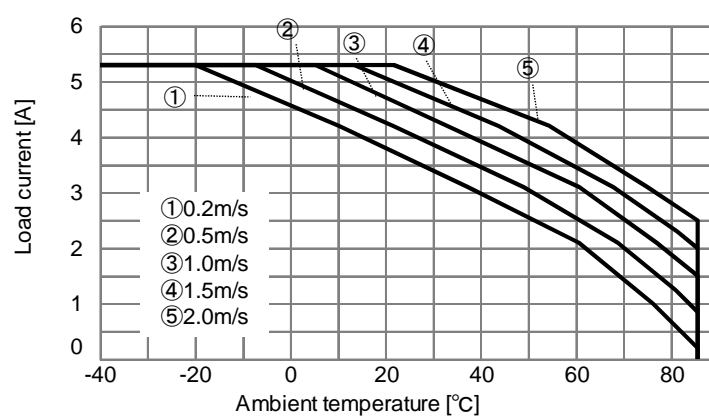


Fig.5.10.57  
Derating curve  
for CHS3004810  
Vin=48V

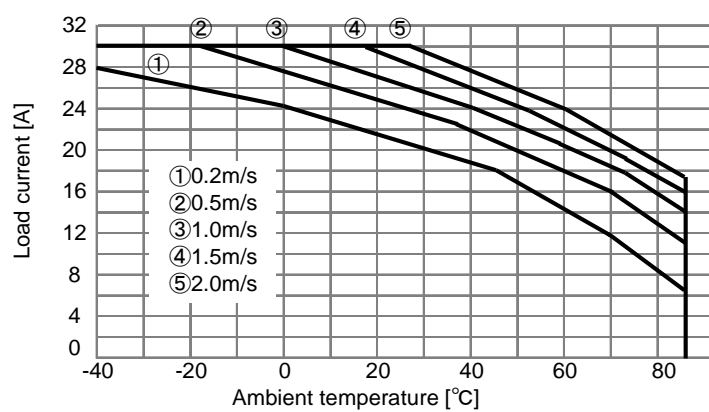


Fig.5.10.58  
Derating curve  
for CHS3004812  
Vin=48V

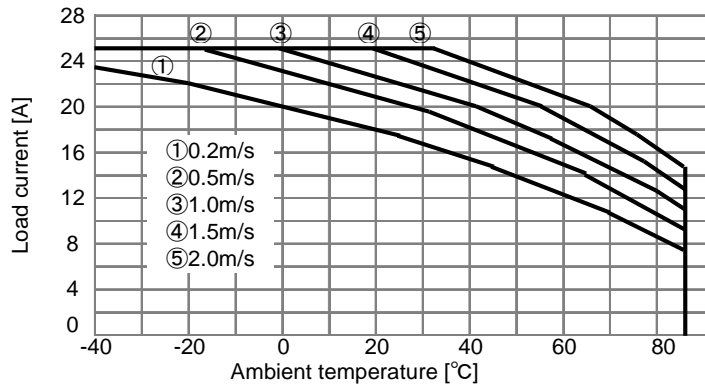


Fig.5.10.59  
Derating curve  
for CHS3004812H  
Vin=48V

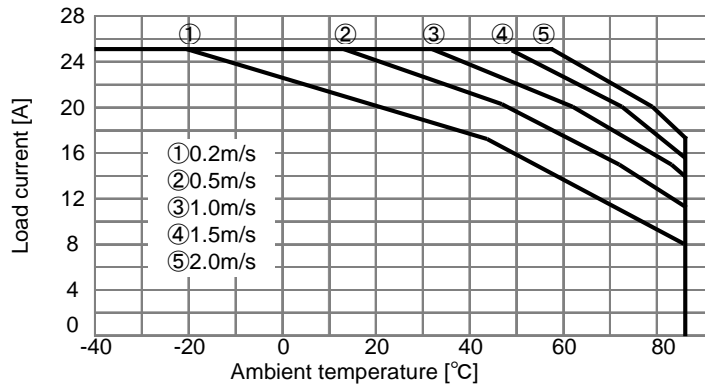


Fig.5.10.60  
Derating curve  
for CHS3004815  
Vin=48V

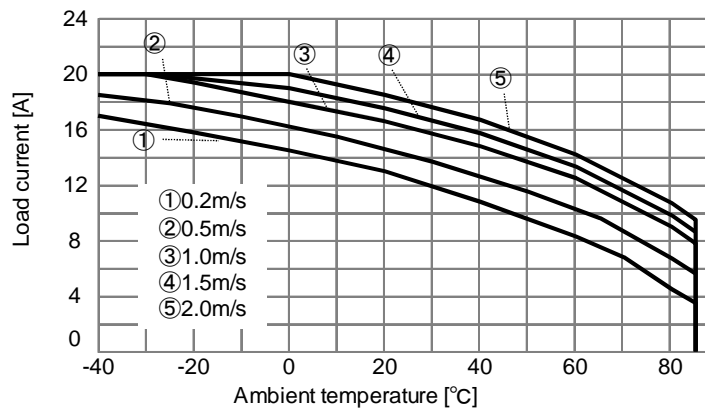


Fig.5.10.61  
Derating curve  
for CHS3004824  
Vin=48V

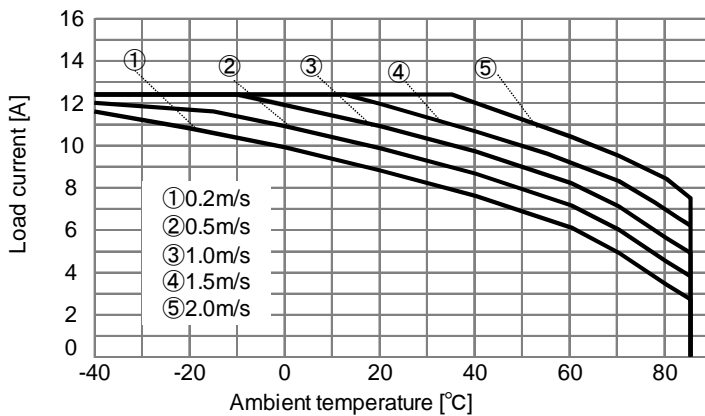


Fig.5.10.62  
Derating curve  
for CHS3004828  
Vin=48V

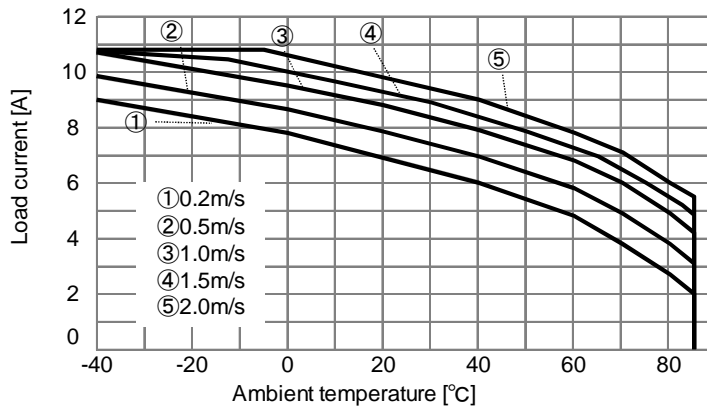


Fig.5.10.63  
Derating curve  
for CHS3004832  
Vin=48V

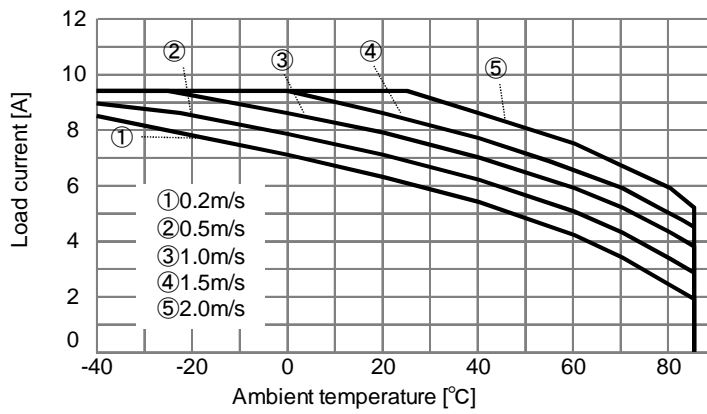


Fig.5.10.64  
Derating curve  
for CHS3004848  
Vin=48V

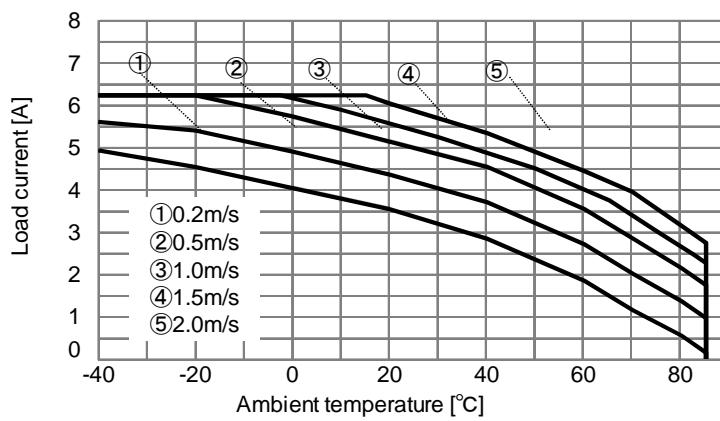


Fig.5.10.65  
Derating curve  
for CHS3804810  
Vin=48V

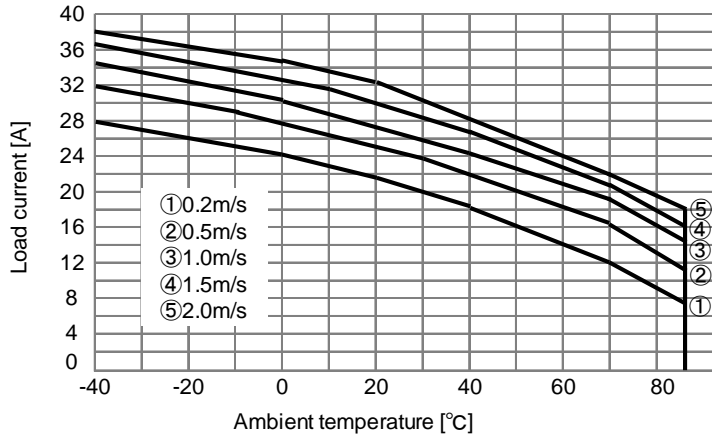


Fig.5.10.66  
Derating curve  
for CHS3804812  
Vin=48V

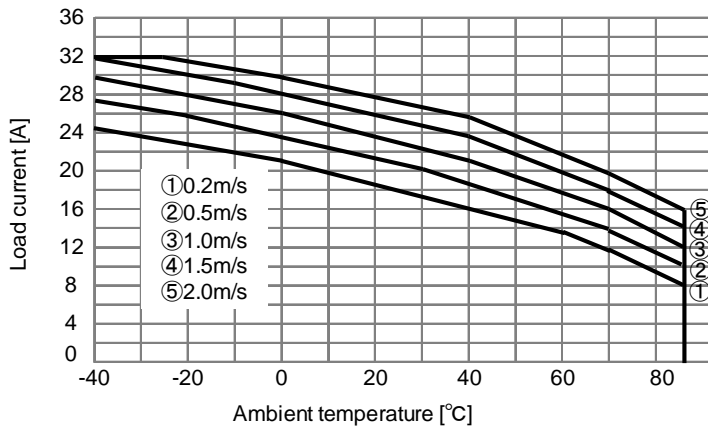


Fig.5.10.67  
Derating curve  
for CHS3804812H  
Vin=48V

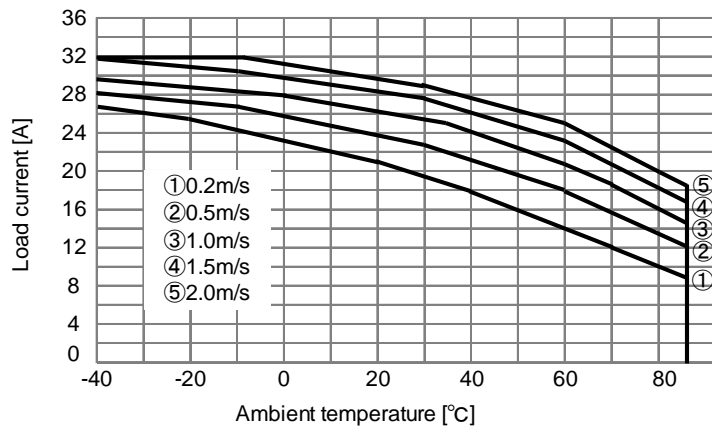


Fig.5.10.68  
Derating curve  
for CHS4002412  
Vin=24V

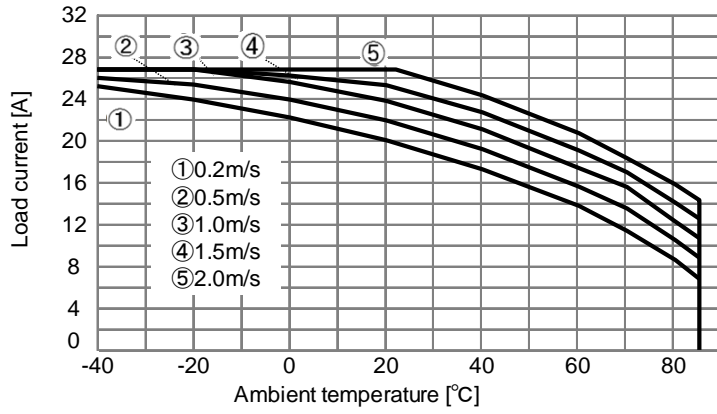


Fig.5.10.69  
Derating curve  
for CHS4002415  
Vin=24V

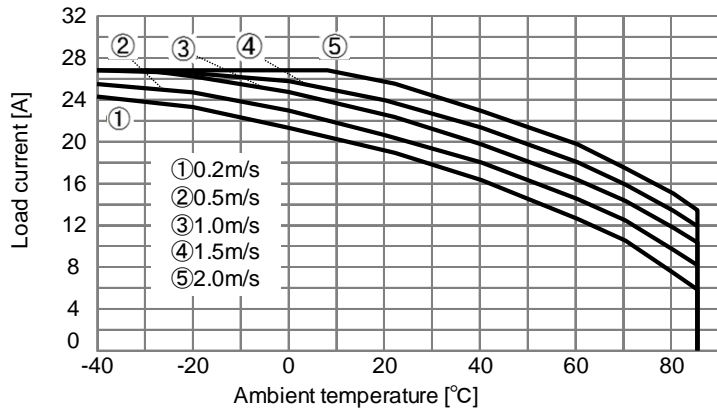


Fig.5.10.70  
Derating curve  
for CHS4002424  
Vin=24V

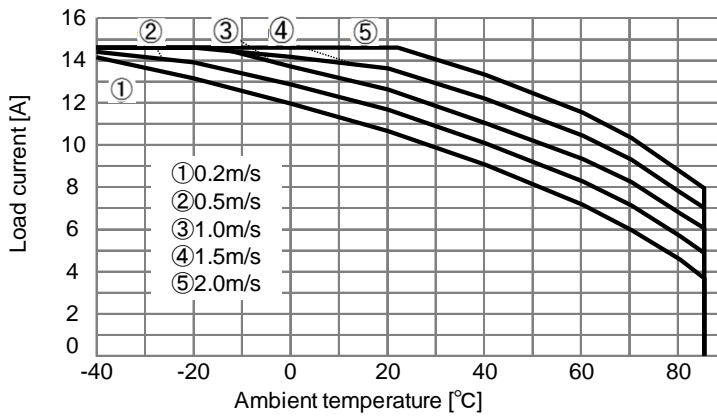


Fig.5.10.71  
Derating curve  
for CHS4002428  
Vin=24V

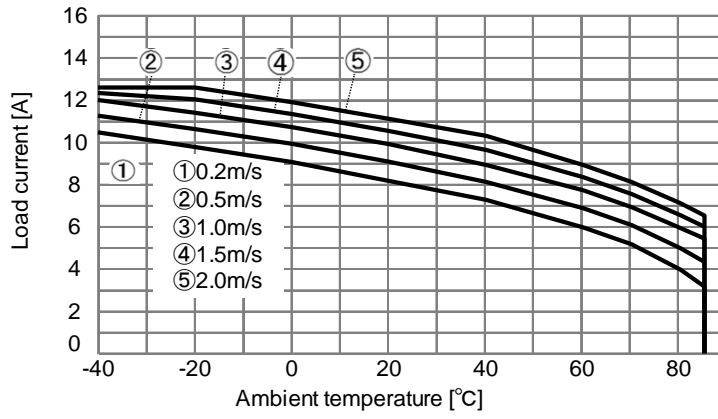


Fig.5.10.72  
Derating curve  
for CHS4002432  
Vin=24V

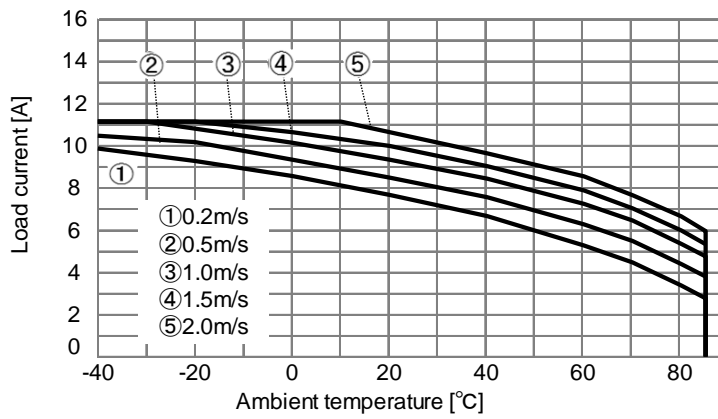


Fig.5.10.73  
Derating curve  
for CHS4002448  
Vin=24V

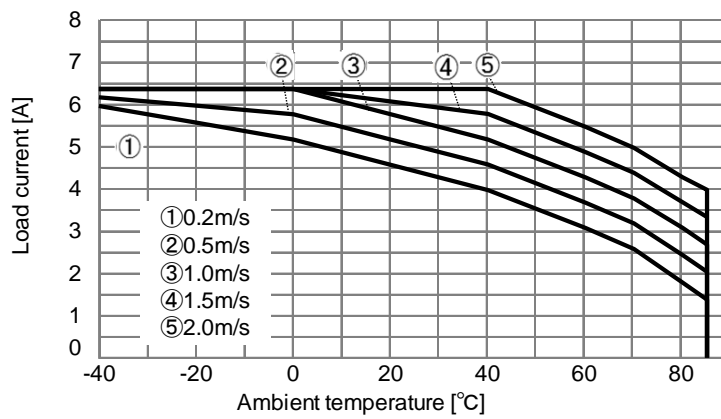




Fig.5.10.74  
Derating curve  
for CHS4004810  
Vin=48V

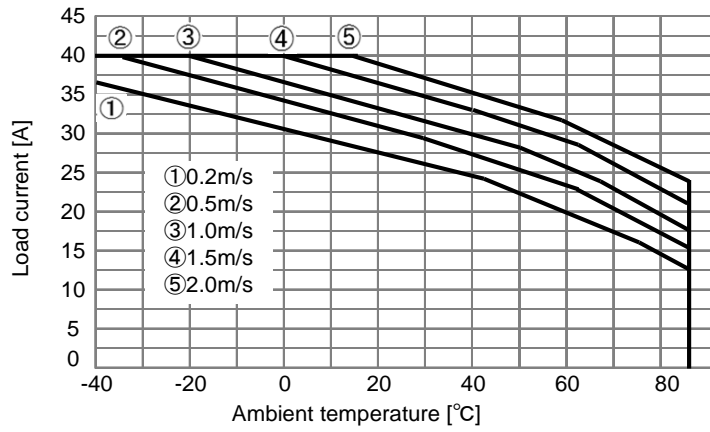


Fig.5.10.75  
Derating curve  
for CHS4004812  
Vin=48V

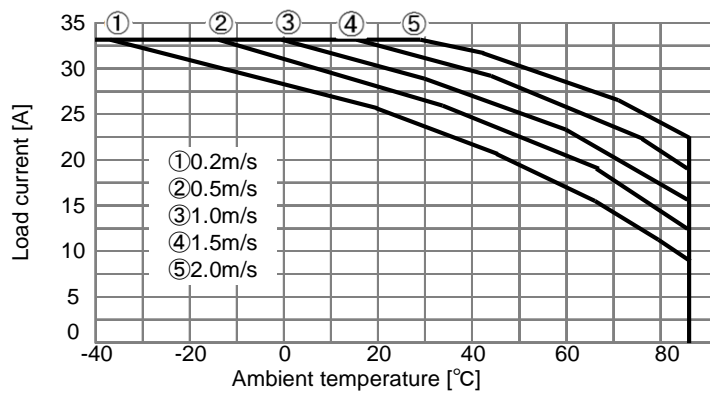


Fig.5.10.76  
Derating curve  
for CHS4004812H  
Vin=48V

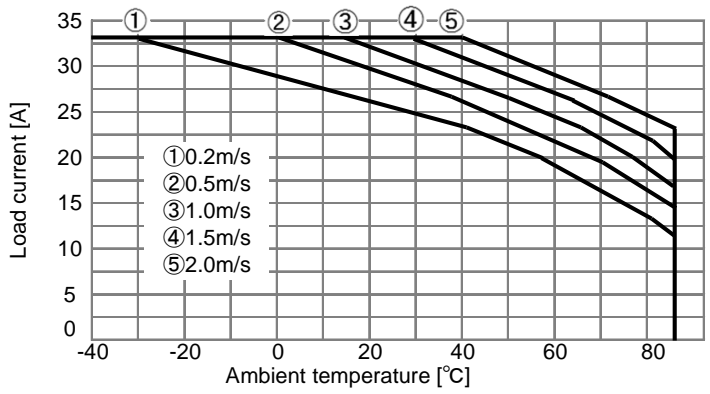


Fig.5.10.77  
Derating curve  
for CHS4004815  
Vin=48V

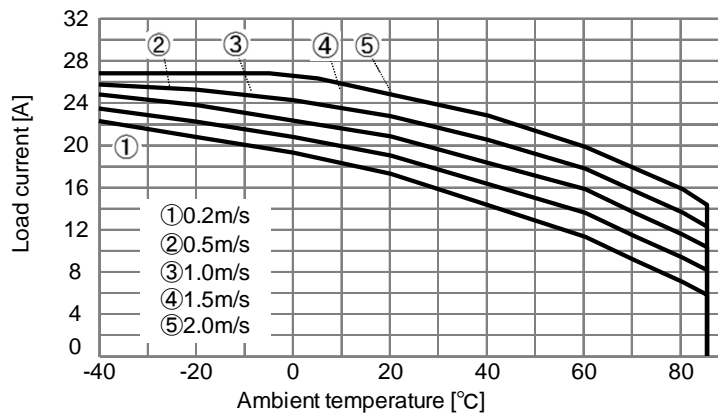


Fig.5.10.78  
Derating curve  
for CHS4004824  
Vin=48V

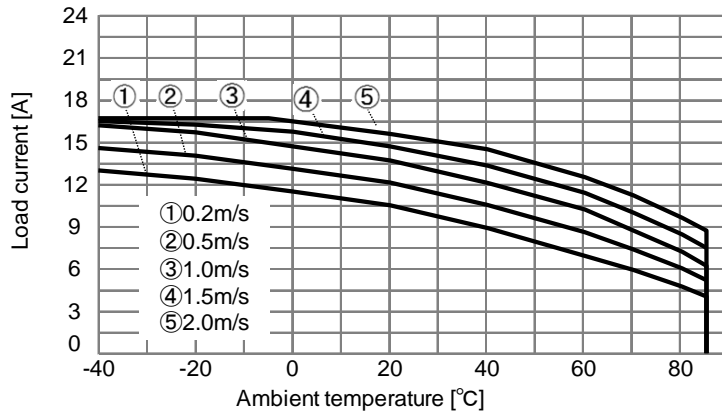


Fig.5.10.79  
Derating curve  
for CHS4004828  
Vin=48V

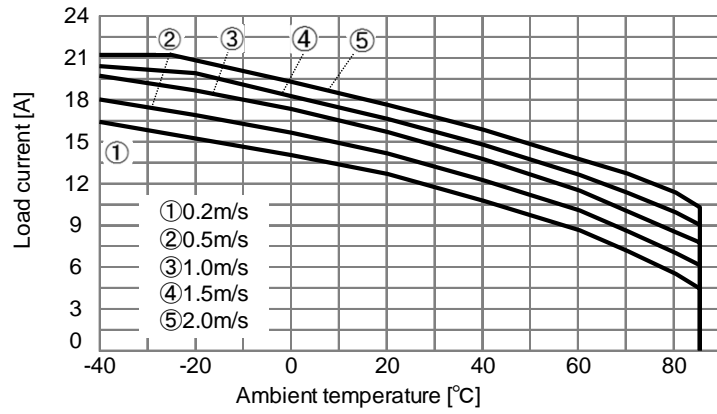


Fig.5.10.80  
Derating curve  
for CHS4004832  
Vin=48V

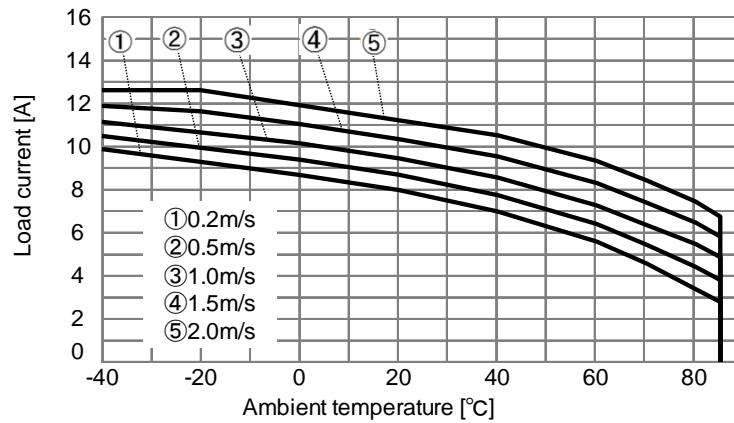


Fig.5.10.81  
Derating curve  
for CHS4004848  
Vin=48V

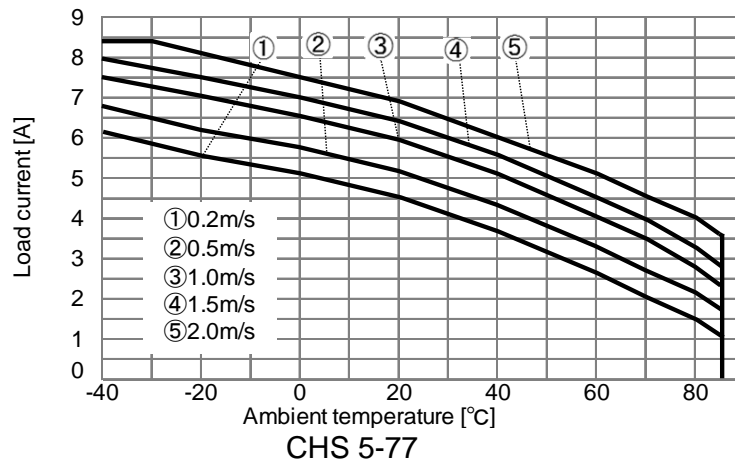


Fig.5.10.82  
Derating curve  
for CHS5004812  
Vin=48V

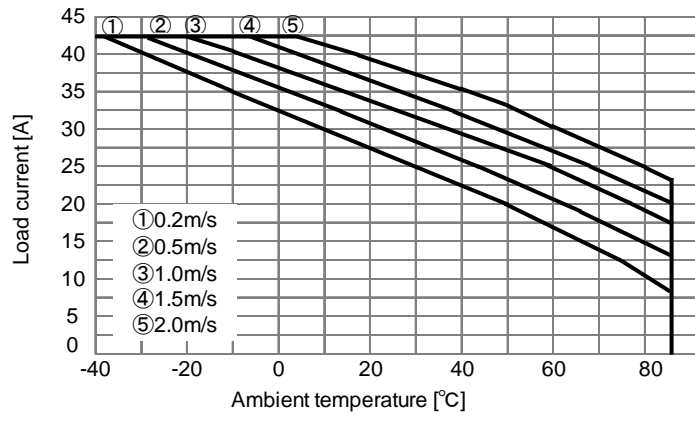
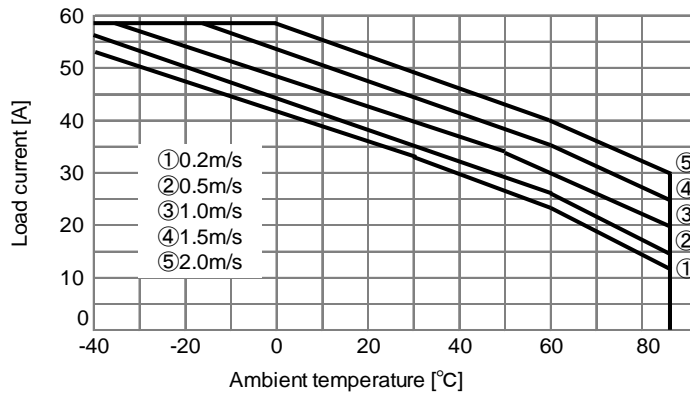


Fig.5.10.83  
Derating curve  
for CHS7004812H  
Vin=48V

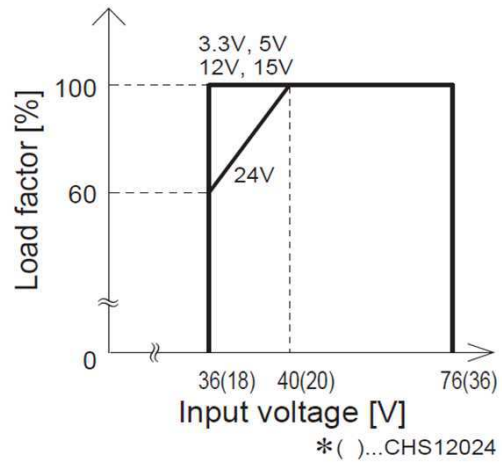


## 5.11 Input Derating

### 5.11.1 CHS120 Input Derating

- CHS120 has derating by input voltage is required. shown Fig.5.11.1

Fig.5.11.1  
Input derating curve  
for CHS120



## 6. Adjustable voltage range

### 6.1 Output voltage adjusting method by external potentiometer

- Output voltage is adjustable by the external potentiometer.
- When the output voltage adjustment is used, note that the over voltage protection circuit operates when the output voltage is set to for CHS
- If the output voltage drops under the output voltage adjustment range, the Low voltage protection operates.
- By connecting the external potentiometer (VR1) and resistors (R1,R2), output voltage becomes adjustable, as shown in Fig.6.1.1. Recommended external parts are shown in Table 6.1.1.
- The wiring to the potentiometer should be as short as possible. The temperature coefficient could become worse, depending on the type of a resistor and potentiometer. Following parts are recommended for the power supply.
  - Resistor : Metal film type, coefficient of less than  $\pm 100\text{ppm/C}$
  - Potentiometer : Cermet type, coefficient of less than  $\pm 300\text{ppm/C}$
- When the output voltage adjustment is not used, open the TRM pin respectively.
- The changes speed of the TRM voltages should be less than  $0.15\text{V/ms}$ .

Fig.6.1.1  
Output voltage  
control circuit

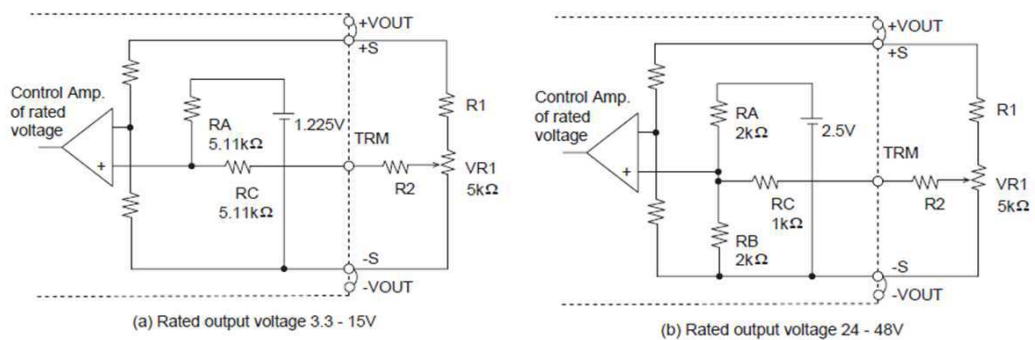


Table 6.1.1  
Recommended value of  
external potentiometer  
& resistor

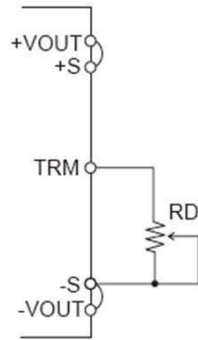
No.	VOUT	Output adjustable range					
		VOUT $\pm 5\%$			VOUT $\pm 10\%$		
		R1	R2	VR1	R1	R2	VR1
1	3.3V	2.2k $\Omega$	68k $\Omega$	5k $\Omega$	2.2k $\Omega$	33k $\Omega$	5k $\Omega$
2	5V	4.7k $\Omega$	68k $\Omega$		5.6k $\Omega$	33k $\Omega$	
3	10V	15k $\Omega$	68k $\Omega$		15k $\Omega$	33k $\Omega$	
4	12V	18k $\Omega$	68k $\Omega$		18k $\Omega$	33k $\Omega$	
5	15V	22k $\Omega$	68k $\Omega$		22k $\Omega$	33k $\Omega$	
6	24V	33k $\Omega$	11k $\Omega$		33k $\Omega$	6.2k $\Omega$	
7	28V	39k $\Omega$	11k $\Omega$		39k $\Omega$	6.2k $\Omega$	
8	32V	51k $\Omega$	11k $\Omega$		51k $\Omega$	6.2k $\Omega$	
9	48V	75k $\Omega$	11k $\Omega$		75k $\Omega$	6.2k $\Omega$	

## 6.2 Output voltage decreasing by external resistor

- By connecting the external resistor (RD), output voltage becomes adjustable to decrease.

The external resistor (RD) is calculated by the following equation.

Fig.6.2.1  
Connection for  
output voltage decreasing



(a) Rated output voltage : 3.3 - 15V

$$RD = \frac{5.11}{\Delta} - 10.22 \text{ [k}\Omega\text{]}$$

(b) Rated output voltage : 24 - 48V

$$RD = \frac{1}{\Delta} - 2 \text{ [k}\Omega\text{]}$$

$$\Delta = \frac{V_{OR} - V_{OD}}{V_{OR}}$$

$V_{OR}$  : Rated output voltage [V]

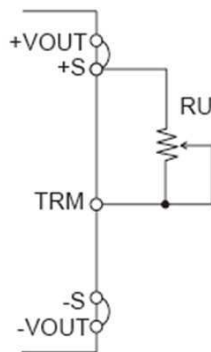
$V_{OD}$  : Output voltage needed to set up [V]

## 6.3 Output voltage increasing by external resistor

- By connecting the external resistor (RU), output voltage becomes adjustable to increase.

The external resistor (RU) is calculated by the following equation.

Fig.6.3.1  
Connection for  
output voltage increasing



(a) Rated output voltage : 3.3 - 15V

$$RU = \frac{5.11 \times V_{OR} \times (1 + \Delta)}{1.225 \times \Delta} - \frac{5.11}{\Delta} - 10.22 \text{ [k}\Omega\text{]}$$

(b) Rated output voltage : 24 - 48V

$$RU = \frac{V_{OR} \times (1 + \Delta)}{1.225 \times \Delta} - \frac{1 + 2 \times \Delta}{\Delta} \text{ [k}\Omega\text{]}$$

$$\Delta = \frac{V_{OU} - V_{OR}}{V_{OR}}$$

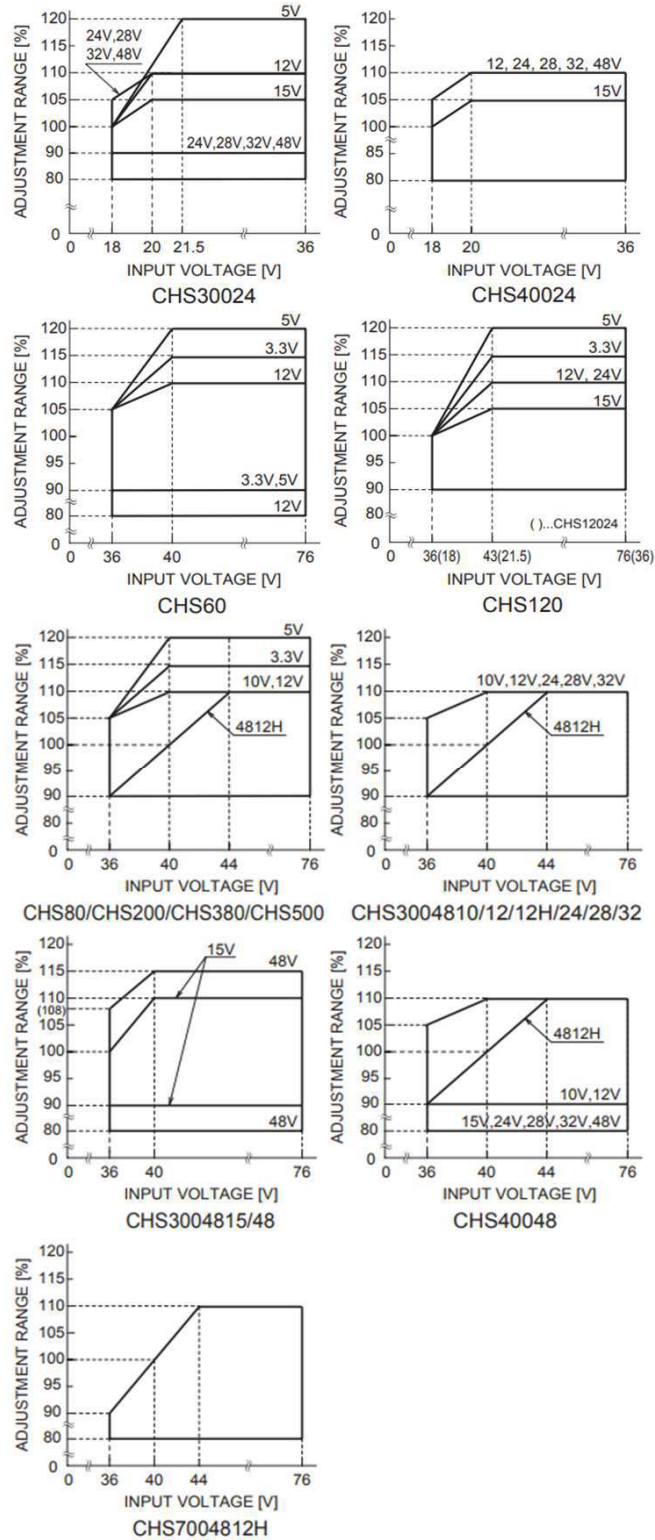
$V_{OR}$  : Rated output voltage [V]

$V_{OU}$  : Output voltage needed to set up [V]

## 6.4 Input voltage derating

- When input voltage is 18-21.5V DC or 36-44V DC, the output voltage adjustment range becomes as shown in Fig.6.4.1.

Fig.6.4.1  
CHS output voltage  
adjustment range



## 7. Protect circuit

### 7.1 Overcurrent Protection

- Over Current Protection (OCP) is built in and works at 105% of the rated current or higher. However, use in an over current situation must be avoided whenever possible. The output voltage of the power module will recover automatically if the fault causing over current is corrected.

When the output voltage drops after OCP works, the power module enters a "hiccup mode" where it repeatedly turns on and off at a certain frequency.

### 7.2 Overvoltage protection

- The overvoltage protection circuit is built-in. The DC input should be shut down if overvoltage protection is in operation. The output voltage of the power module will recover automatically if the fault causing over voltage is corrected.

Remarks :

Please note that devices inside the power supply might fail when voltage more than rated output voltage is applied to output pin of the power supply. This could happen when the customer tests the overvoltage performance of the unit.

### 7.3 Thermal protection

- When the power supply temperature is kept above 120°C, the thermal protection will be activated and simultaneously shut down the output. The output voltage of the power supply will recover automatically if the unit is cool down,

#### ● Option "-U"

Option "-U" means output is shut down when the abovementioned protection circuit is activated.

If this happens, protection circuit can be inactivated by cycling the DC input power off for at least 1 second or toggling Remote ON/OFF signal.



## 8. Remote ON/OFF

- Remote ON/OFF circuit is built-in on the input side (RC).  
The ground pin of input side remote ON/OFF circuit is "-VIN" pin.

Table 8.1.1  
Specification of  
Remote ON/OFF  
(CHS80, CHS200)

	ON/OFF logic	Between RC and GND	Output voltage
Standard	Negative	L level(0 - 0.8V) or short	ON
		H level(2.0 - 7.0V) or open	OFF
Optional -R	Positive	L level(0 - 0.8V) or short	OFF
		H level(2.0 - 7.0) or open	ON

When RC is "Low Level, fan out current is 0.1mA typ.

When Vcc is applied, use  $2.0 \leq V_{cc} \leq 7.0V$ .

Table 8.1.2  
Specification of  
Remote ON/OFF  
(CHS60, CHS120, CHS300  
CHS380, CHS400  
CHS500, CHS700)

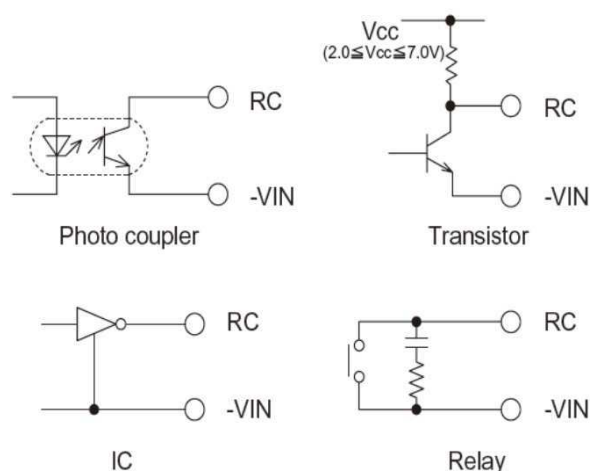
	ON/OFF logic	Between RC and GND	Output voltage
Standard	Negative	L level(0 - 0.8V) or short	ON
		H level(4.0 - 7.0V) or open	OFF
Optional -R	Positive	L level(0 - 0.8V) or short	OFF
		H level(4.0 - 7.0) or open	ON

When RC is "Low Level, fan out current is 0.1mA typ.

When Vcc is applied, use  $4.0 \leq V_{cc} \leq 7.0V$ .

- When remote ON/OFF function is not used, please short between RC and -VIN (-R: open between RC and -VIN).

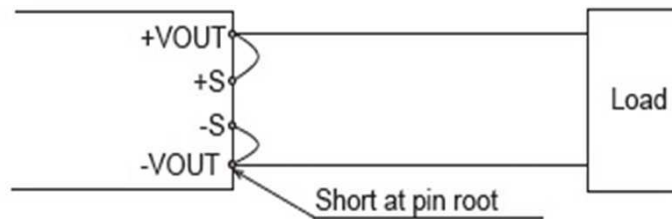
Fig 8.1.1  
RC connection  
example



## 9. Remote sensing

### 9.1 When the remote sensing function is not in use

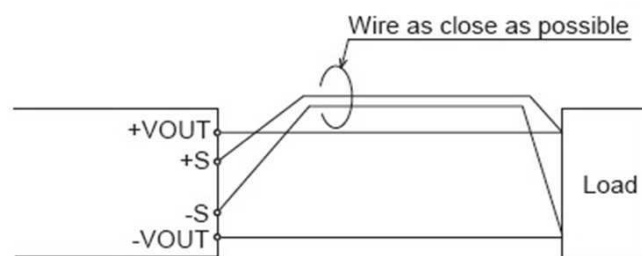
Fig. 9.1.1  
Connection  
when the remote  
sensing is not in use



- When the remote sensing function is not in use, it is necessary to confirm that pins are shorted between +S and +VOUT, and between -S and -VOUT.
- Wire between +S and +VOUT, and between -S and -VOUT as short as possible. Loop wiring should be avoided. This power supply might become unstable by the noise coming from poor wiring.

### 9.2 When the remote sensing function is in use

Fig. 9.2.1  
Connection  
when the remote  
sensing is in use



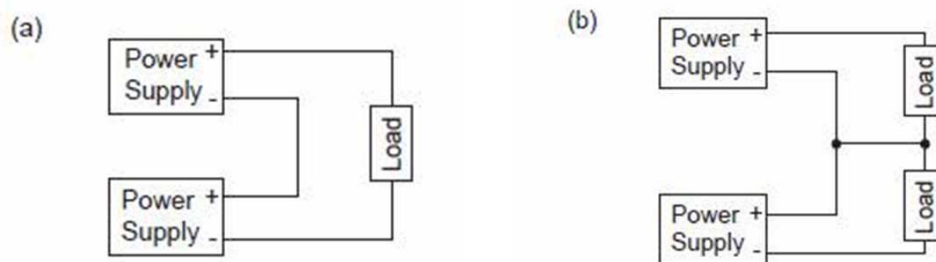
- Twisted-pair wire or shield wire should be used for sensing wire.
- Thick wire should be used for wiring between the power supply and a load. Line drop should be less than 0.3V. Voltage between +VOUT and -VOUT should remain within the output voltage adjustment range.
- If the sensing patterns are short, heavy-current is drawn and the pattern may be damaged. The pattern disconnection can be prevented by installing the protection parts as close as possible to a load.
- Output voltage might become unstable because of impedance of wiring and load condition when length of wire exceeds 40cm.

## 10. Serise operation / Parallel operation / Redundancy operation

### 10.1 Series operation

- Series operation is available by connecting the outputs of two or more power supplies, as shown below. Output current in series connection should be lower than the lowest rated current in each unit.

Fig. 10.1.1  
Example of  
Series operation



### 10.2 Parallel operation (CHS400 / CHS500 option "-P")

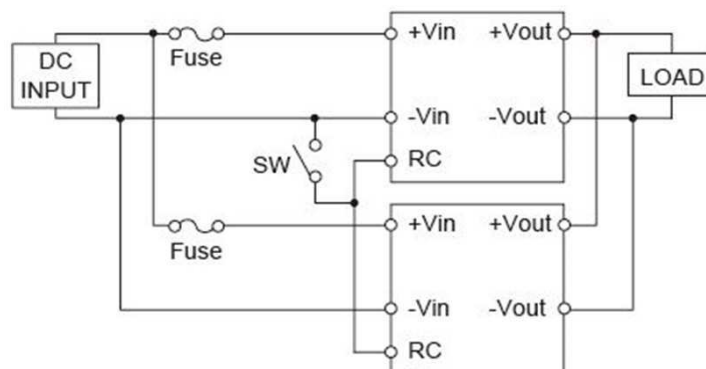
- Sensing and adjustment of the output voltage are not possible at the time of the use with option.
- As variance of output current draw from each power supply is maximum 10%, the total output current must not exceed the value determined by the following equation.

$$\begin{aligned} & \text{( Output current the Parallel operation )} \\ & = (\text{the rated current per unit}) \times (\text{number of unit}) \times 0.9 \end{aligned}$$

When the number of units in parallel operation increases, input current increase at the same time. Adequate wiring desing for input circuitry is required, such as circuit pattern, wiring and currentcapacity for equipment.

- Total number of units should be no more than 3 pieces.
- Thick wire should be used for wiring between the power supply and load, and line drop should be less than 0.3V.
- Connect each input pin for the lowest possible impedance.
- When the number of the units in parallel operation increases, inputcurrent increases. Adequate wiring design for input circuitry such as circuit pattern, wiring and current for equipment is required.

Fig. 10.2.1  
Example of  
parallel operation

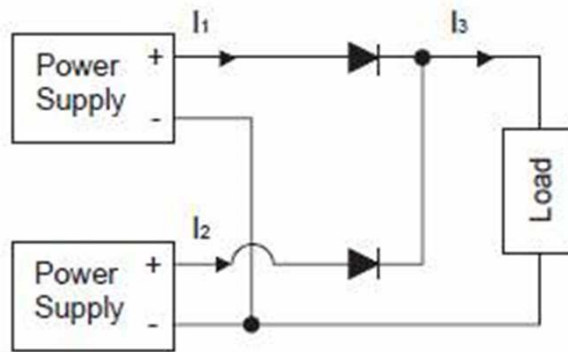


### 10.3 Redundancy operation

---

- Redundancy operation is available by wiring as shown below.

Fig. 10.3.1  
Example of  
Redundancy operation



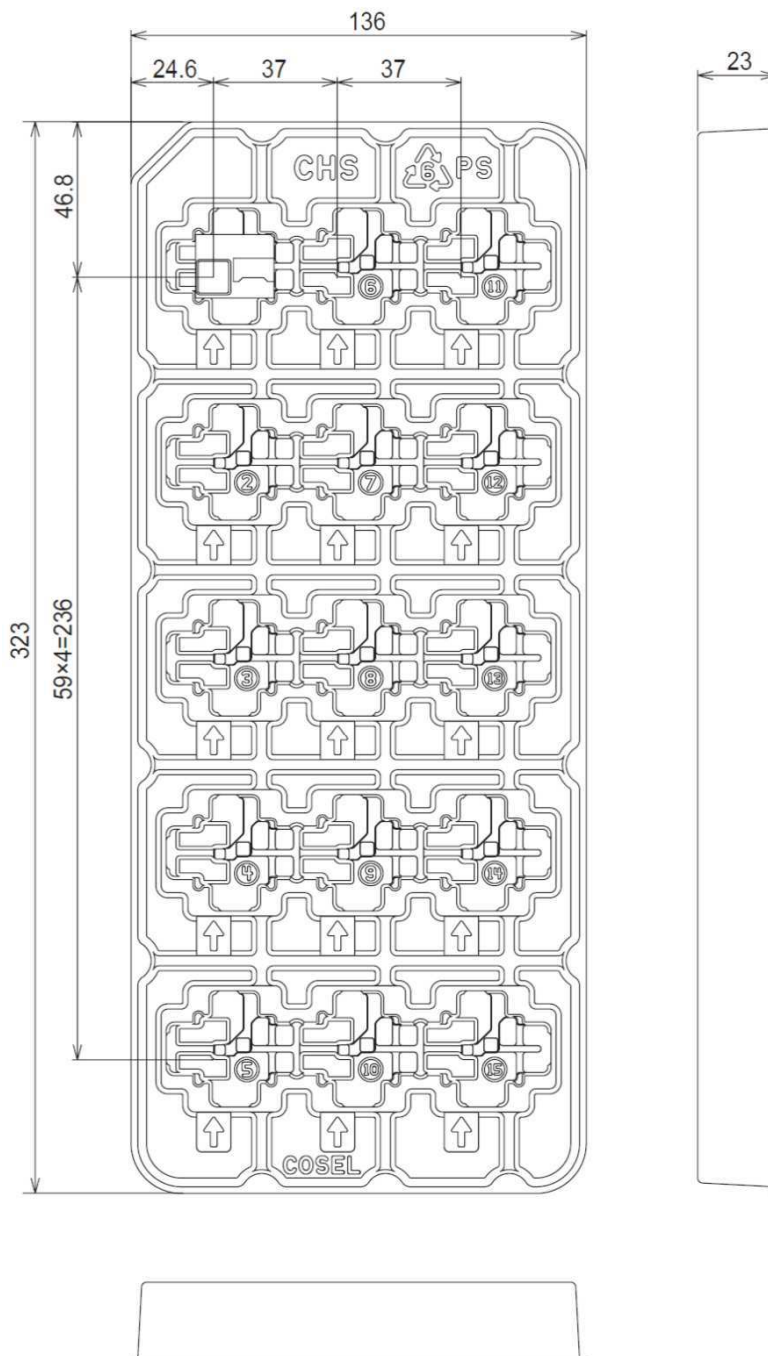
- Even a slight difference in output voltage can affect the balance between the values of  $I_1$  and  $I_2$ . Please make sure that the value of  $I_3$  does not exceed the rated current of the power supply.

$$I_3 \leq \text{the rated current value}$$

## 11. SMDtype(option "-S")package information

- These are packed in a tray (Fig.11.1.1 to 11.1.3)  
Please order "CHS□□-S" for tray type packaging.  
Capacity of the tray is 15max.  
In case of fractions, the units are stored in numerical order.

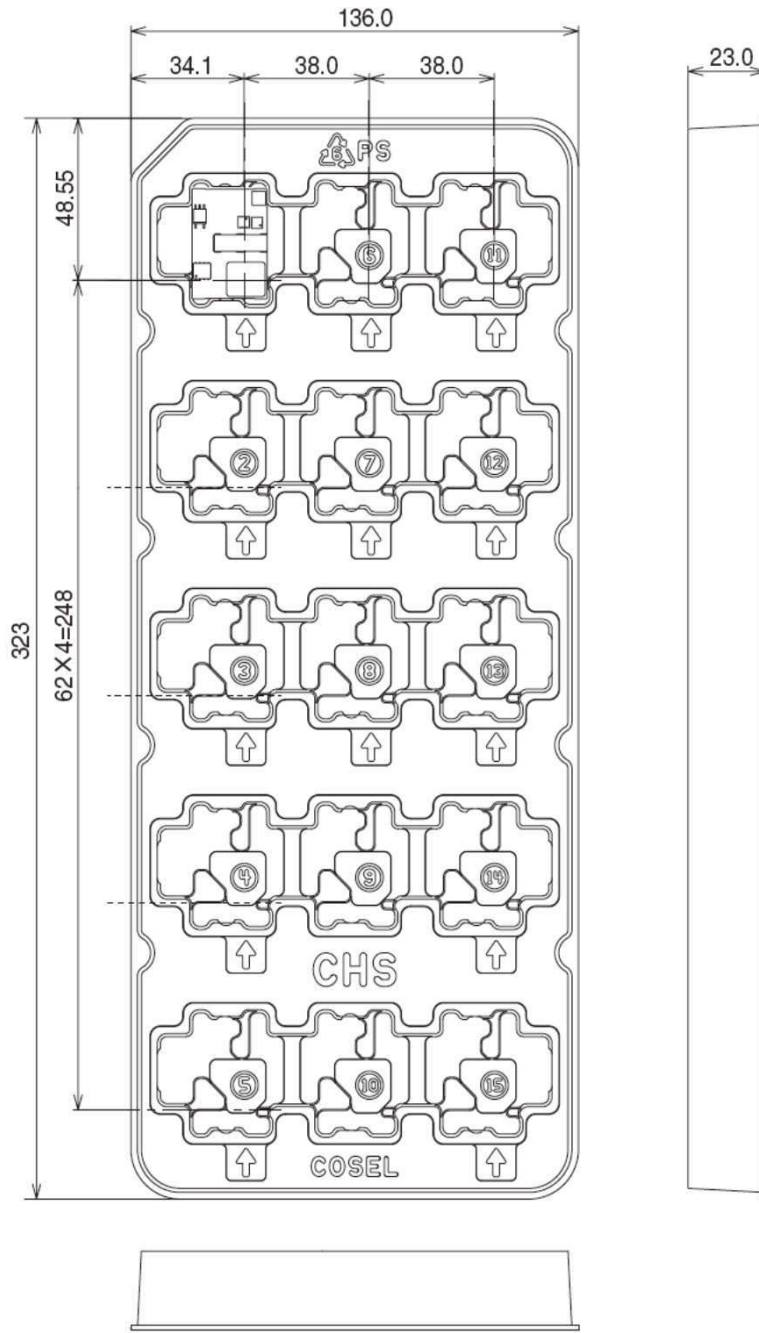
Fig. 11.1.1  
Delivery package  
information(CHS60)



Dimensions in mm  
Material : Conductive PS

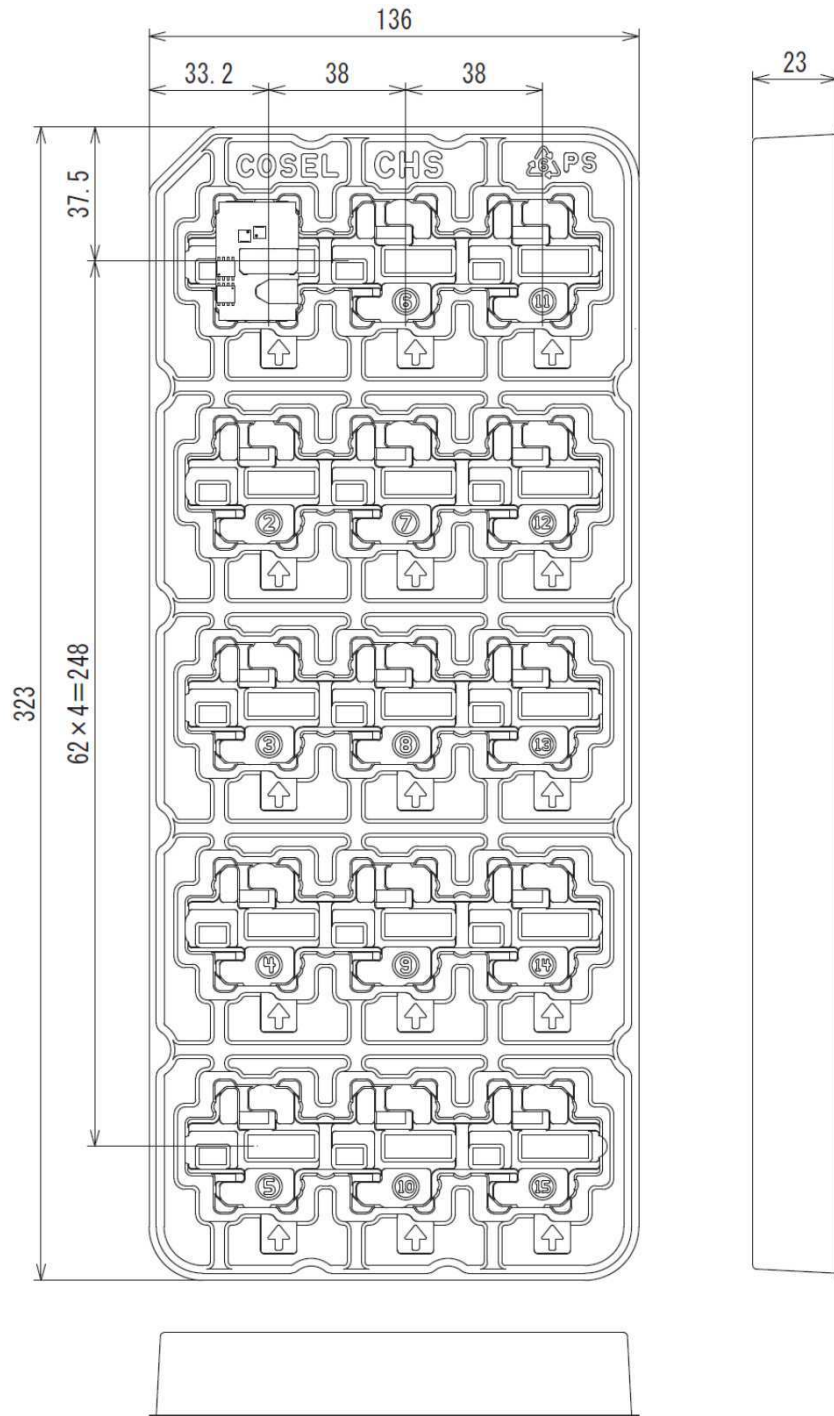
CHS 11-1

Fig. 11.1.2  
Delivery package  
information(CHS80)



Dimensions in mm  
Material : Conductive PS

Fig. 11.1.3  
Delivery package  
information(CHS120)



Dimensions in mm  
Material : Conductive PS